

DENON®

PMA-1700NE  
Integrated Amplifier

# QUICK START GUIDE

# Before you begin

## What's in the box

---

Quick Start Guide



Safety Instructions



Warranty  
(for North America  
model only)



Integrated amplifier



Power cord



Remote control  
(RC-1249)



2× R03/AAA batteries



## Required for setup

---

Source device  
(e.g. CD player, Network  
audio player, Turntable, TV)

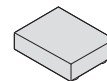

Speakers



Speaker cables



## Optional

---

Computer



USB cable



# Setup

## 1 Connect your speakers

Connect your speaker cables between the PMA-1700NE and your speakers.

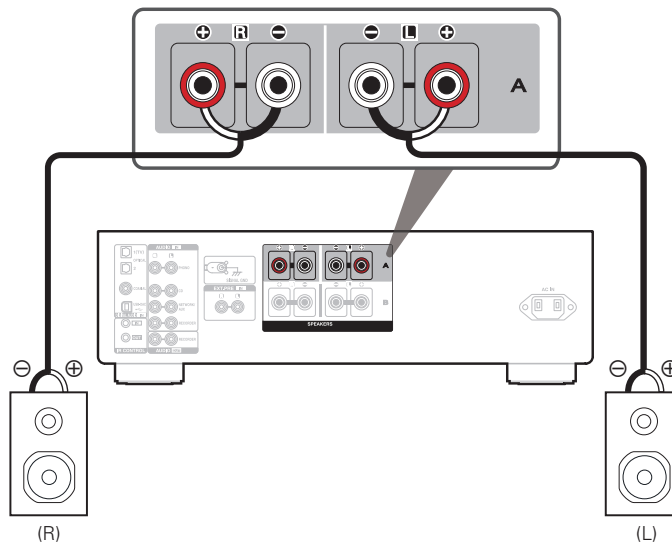

# 2

## Connect your source device

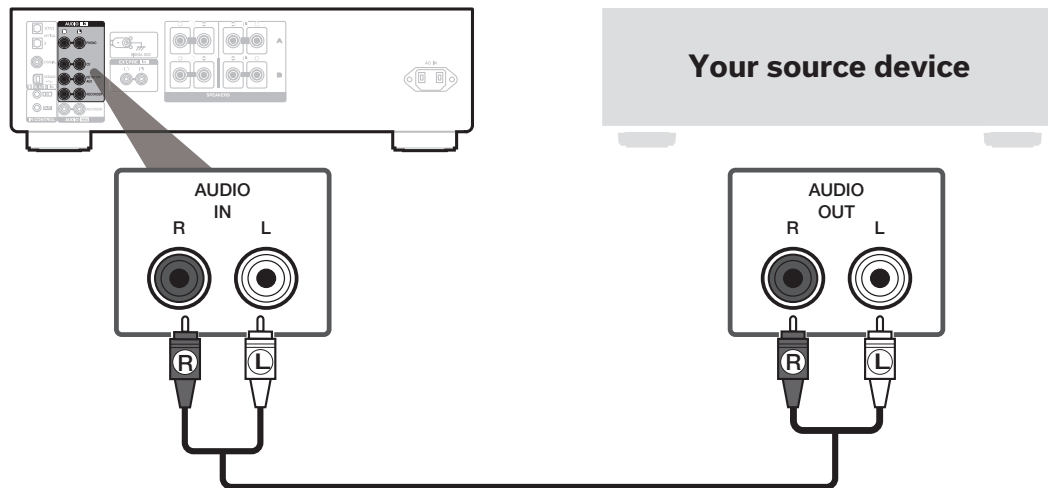

- For details, see the online owner's manual.  
[manuals.denon.com/PMA1700NE/NA/EN/](https://manuals.denon.com/PMA1700NE/NA/EN/)



### 3 Connect to power

Connect the power cord between the PMA-1700NE and a wall outlet.

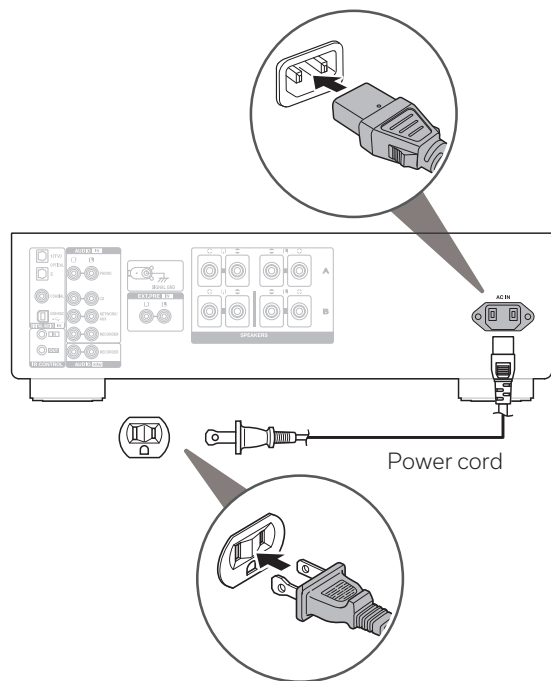

### 4 Install batteries in the remote control

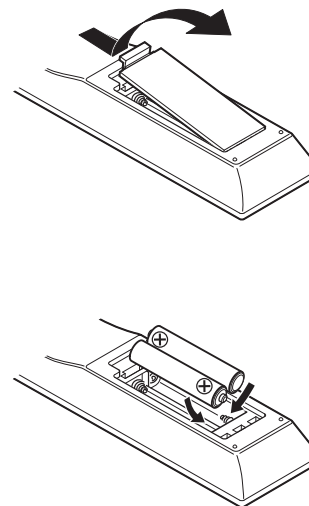

- Batteries can be taken out in reversed order.

# 5 Begin source playback

- 1** Turn VOLUME on the main unit to adjust the volume to the lowest level before turning on the power.

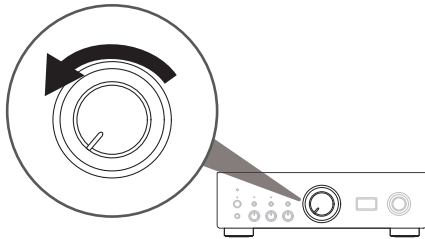

- 2** Press  on this unit to turn the power on.

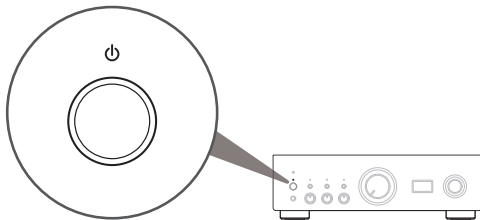

- 3** Set the input source to the desired source device (e.g. CD player, Network audio player, Turntable, TV).

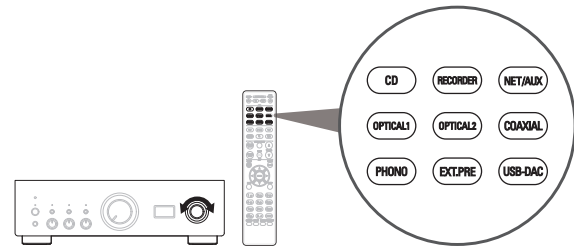

- 4** Ensure source device is connected to power and play content.

- 5** Adjust the volume.

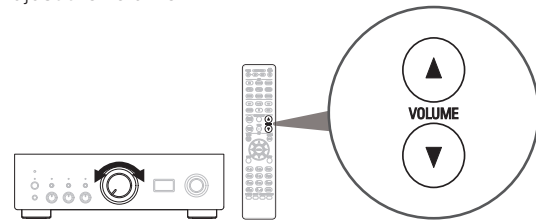

## 6 Listen to computer audio via USB-DAC

### 1 Install the Windows driver software

#### NOTE

The installation of the driver software is not necessary in the following cases.

- When you do not play back the music from a PC using USB-DAC of this unit.
- When using a macOS.

The driver software cannot be installed correctly if your PC is connected to the unit by a USB cable. If the unit and your computer are connected by a USB cable and the computer is switched on before installation, disconnect the USB and restart the computer.

#### Windows OS

System requirements : Windows 10 or Windows 11

- 1 Download the dedicated driver from the "Download" section of the PMA-1700NE page of the Denon website ([www.denon.com](http://www.denon.com)) onto your PC.
- 2 Unzip the downloaded file, and double-click the exe file.

### 3 Install the driver.

- ① Select the language to use for the installation.
- ② Click "OK".

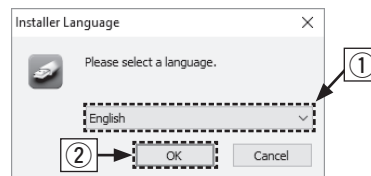

- ③ The wizard menu is displayed. Follow the instructions on the screen.
- ④ When the wizard is completed, click "Yes".

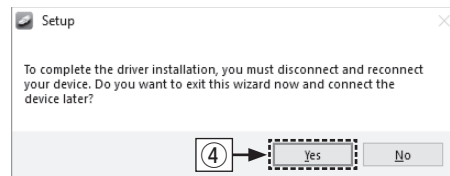

#### NOTE

Please see the FAQ at [www.denon.com](http://www.denon.com) if you experience any issues getting audio to play from your computer through the PMA-1700NE. You may also want to check the support pages for audio player application.



## 2 Connect to PC or Mac

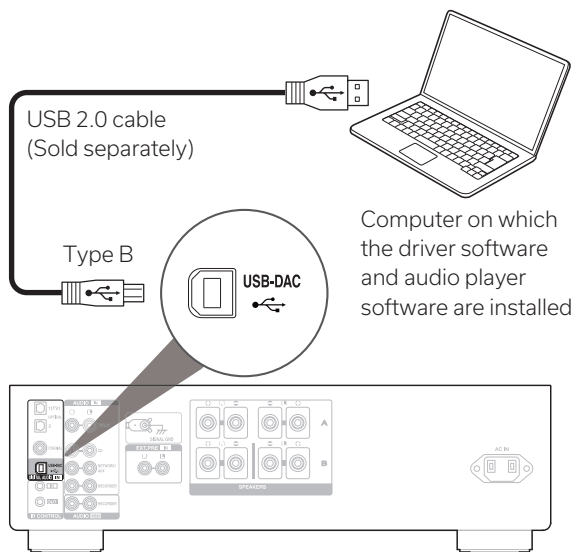

## 3 Listen to audio from PC or Mac

1 Power on.

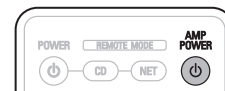

2 Press USB-DAC to switch the  
input source to "USB-DAC".

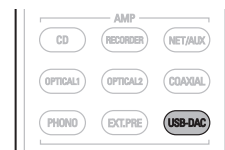

3 Set the audio signal destination to this unit on the computer.

### Windows OS

- 1 Click the "Start" button and click "Control Panel" on the PC.
  - The control panel setting list is displayed.
- 2 Click the "Sound" icon.
  - The sound menu window is displayed.



- ③ Check that there is a checkmark next to "Default Device" under in "PMA-1700NE" of the "Playback" tab.
  - When there is a checkmark for a different device, click "PMA-1700NE" and "Set Default".
- ④ Select "PMA-1700NE" and click "Properties".
  - The PMA-1700NE properties window is displayed.

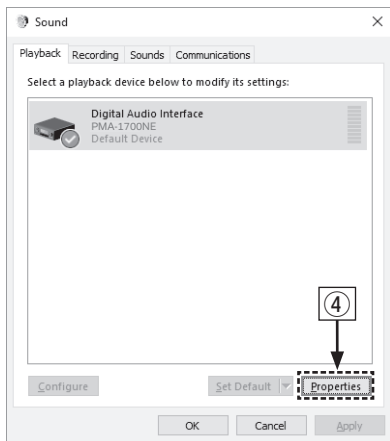

- ⑤ Click the "Advanced" tab.
- ⑥ Select the sampling rate and bit rate to be applied to the D/A converter.
  - It is recommended that "2 channel, 32 bit, 192000 Hz (Studio Quality)" is selected.
- ⑦ Click "Apply".
- ⑧ Click "Test".
  - Check that audio from this unit is output from the PC.

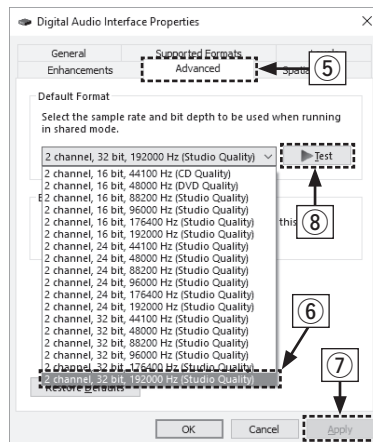

## macOS

System requirements: macOS 11 or 12

- ① Move the cursor to "Go" on the computer screen, and then click "Utilities".
  - The utility list is displayed.
- ② Double-click "Audio MIDI Setup".
  - The "Audio Devices" window is displayed.
- ③ Check that "Use This Device For Sound Output" is checked in "PMA-1700NE".
  - If a different device is checked, select and "Secondary click" on "PMA-1700NE", and then select "Use This Device For Sound Output".
- ④ Select the "PMA-1700NE" format.
  - It is normally recommended to set the format to "2 ch 32-bit Integer 384.0 kHz".

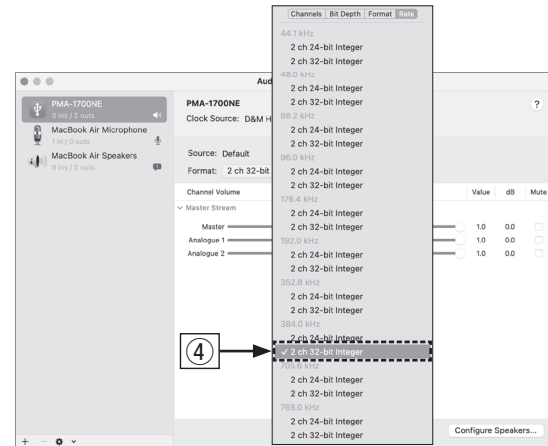
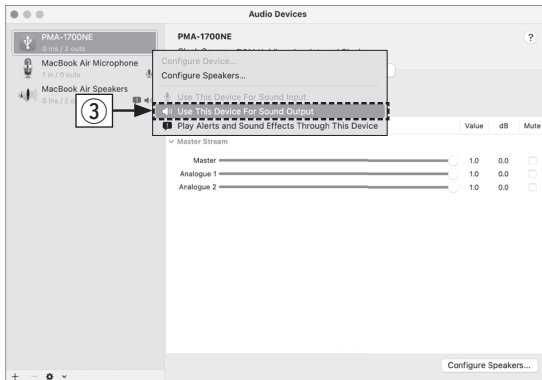

- ⑤ Quit Audio MIDI Setup.

# Owner's manual

EN

FR

ES

- 4** Use your favorite music applications on your PC/Mac to play audio through the PMA-1700NE.
- For high resolution audio playback you will need to obtain an advanced audio player software such as JRiver Media Center or Audirvana.

## NOTE

Additional settings to output audio to the PMA-1700NE may have to be selected in your advanced audio player application. Please refer to the user's manual for your application.

Refer to the online manual for other functions information and operation procedure details.

[manuals.denon.com/PMA1700NE/NA/EN/](http://manuals.denon.com/PMA1700NE/NA/EN/)



Online manual

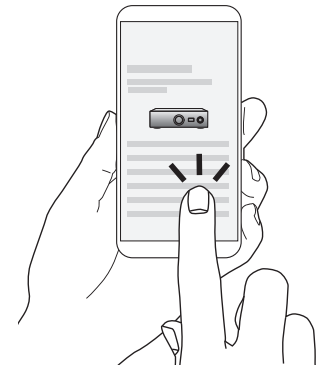

For more information, visit [www.denon.com](http://www.denon.com)

**DENON®**

[www.denon.com](http://www.denon.com)

Printed in Japan 5411 11990 00AD  
© 2022 Sound United. All Rights Reserved.