

DENON®

PMA-900HNE

Integrated Network Amplifier

Quick start guide

Before you begin

What's in the box

Quick start guide



Safety Instructions



Warranty
(for North America
model only)



Notes on radio

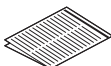

Network Integrated
Amplifier

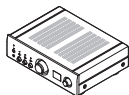

Power cord



Remote control
(RC-1246)

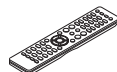

2× R03/AAA batteries



External antennas
for Bluetooth®/Wi-Fi®
connectivity



Required for setup

Speakers



Speaker cables



Mobile device



Wi-Fi Router and
Internet connection

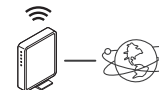

Optional

Ethernet cable



Setup

1 Connect the antennas

- 1 Place the antenna squarely over the antenna terminal in the upper-left or upper-right corner of the rear panel.
- 2 Turn the antenna clockwise until it is fully connected. Do not over tighten.
- 3 Rotate the antenna upwards for the best possible reception.

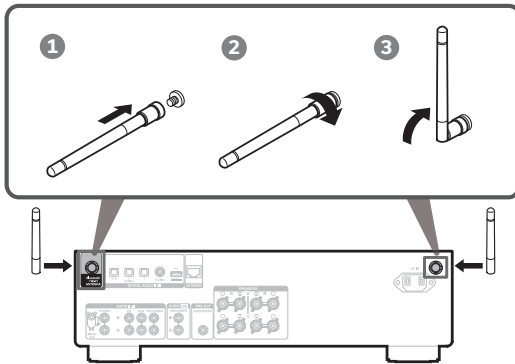

NOTE

The antennas are required for both Bluetooth and Wi-Fi functions.

Optional

If you are connecting PMA-900HNE to a wired network, connect an Ethernet cable (not included) between the amplifier and your router. Do not connect the Ethernet cable if you are connecting the amplifier to a wireless network.

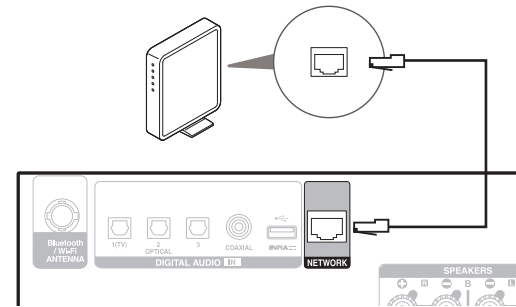

2

Connect your speakers

Connect your speaker cables between the PMA-900HNE and your speakers.

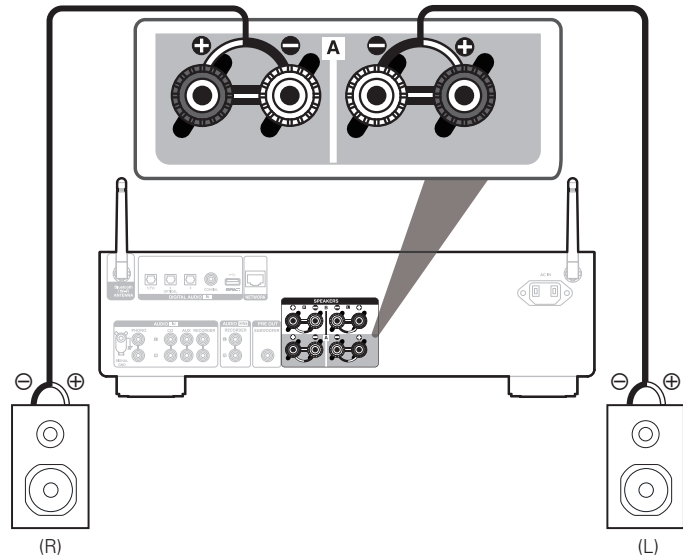

3 Connect to power

Connect the power cable between the PMA-900HNE and a wall outlet.

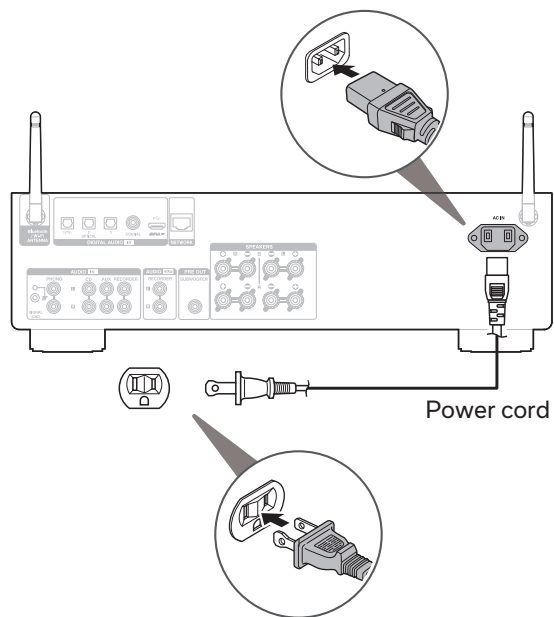

4 Install batteries in the remote control

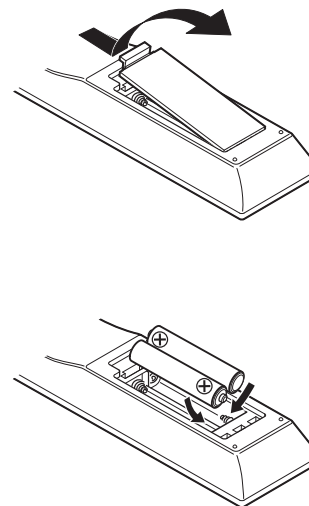

- Batteries can be taken out in reversed order.

5 Use the HEOS app to complete PMA-900HNE setup

- 1 Go to the Apple App Store, Google Play or Amazon App Store and search for "HEOS" to download and install.



- 2 Launch the HEOS app and follow the instructions in the app.

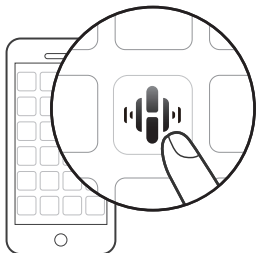

6 Add device

If you already have the HEOS app and have setup at least one HEOS built-in device, please follow the steps below to add the PMA-900HNE to your wireless network.

- 1 Select the Settings  icon in the upper-left corner of the main "Music" menu to display the Settings menu.

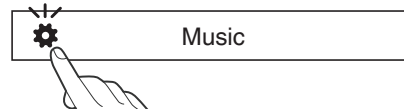

- 2 Select "Add Device" from the HEOS app's Settings menu and follow the instructions:

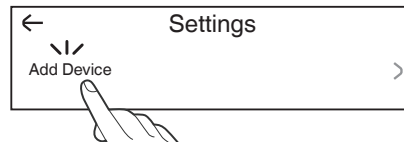

Playing music - Bluetooth

1 Press Bluetooth to select Bluetooth.

When you use it for the first time, the amplifier automatically enters pairing mode and "Bluetooth Pairing..." appears on the display.

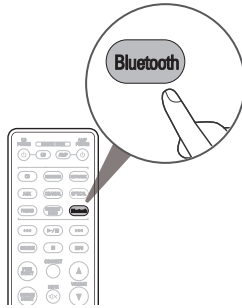
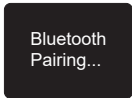

2 Activate Bluetooth on your mobile device.

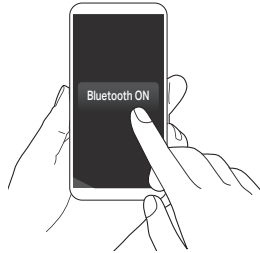

3 Select "Denon PMA-900HNE" from the Bluetooth device list.

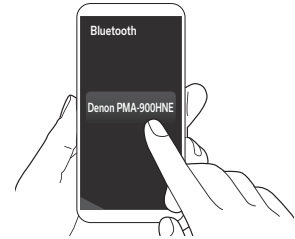

4 Play music using any app on your device.

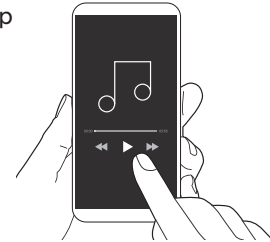

- To pair with other Bluetooth devices, press and hold Bluetooth on the remote control until "Bluetooth Pairing..." is displayed on the unit.

Owner's manual

Refer to the online manual for other functions information and operation procedure details.

manuals.denon.com/PMA900HNE/NA/EN/



Online manual

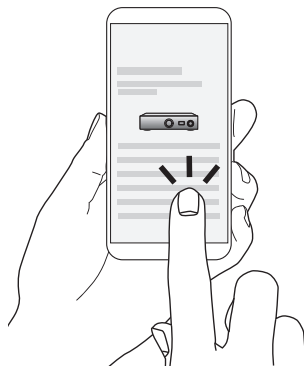

For more information, visit www.denon.com

Trademark information



The Bluetooth® word mark and logos are registered trademarks owned by the Bluetooth SIG, Inc. and any use of such marks by D&M Holdings Inc. is under license. Other trademarks and trade names are those of their respective owners.



The Wi-Fi CERTIFIED logo is a registered trademark of the Wi-Fi Alliance. Wi-Fi Certification provides assurance that the device has passed the interoperability test conducted by the Wi-Fi Alliance, a group that certifies interoperability among wireless LAN devices.

DENON®

www.denon.com

Printed in Vietnam 5411 11959 00AD
© 2022 Sound United. All Rights Reserved.