

Luxman

COMPACT DISC PLAYER

D-380

Owner's Manual

Contents

Precautions	1
Features of This Unit.....	3
Discs This Unit Can Play Back.....	4
Before Use	5
Names and Functions.....	7
Connections	13
How to Play Back Discs	15
Stop/pause the Playback.....	17
Skip/Fast-forward/Rewind	19
Direct search/repeated playback	21
Program Playback	23
Random playback/disc information/zoom	25
Detailed Settings	27
Block Diagram.....	29
Specifications	30
Before Asking for Repair Service.....	31

Precautions

DO NOT move this unit during playback.

During playback, the disc is rotating at high speed. Do not try to lift or move this unit as the disc may be damaged. Otherwise, the disc may be damaged.

When moving this unit

You must remove the disc and close the disc tray when moving this unit. Then, press the OPERATION switch, and after turning off the power, unplug the power cord from the AC outlet. If the unit is moved with a disc remaining inside, this can cause a malfunction.

Installation place

Install this unit in a location where good ventilation and heat radiation are assured.

Especially, the installation of this unit where the direct sunlight is present, where the temperature rises excessively high such as close to a heater, or where it is humid or dusty may cause a malfunction even if heat is efficiently released. Therefore, do not install this unit in such places.

Note:

For heat dispersal, do not install this equipment in a confined space such as a book case or similar unit.

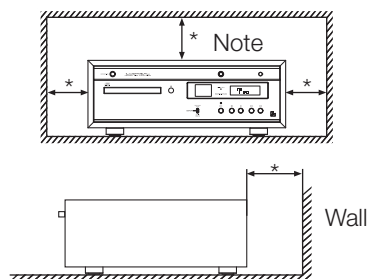

- Install the unit in a stable place such as in the audio rack.
- Do not install this unit near a television or color monitor. Keep this unit away from such devices as cassette decks that are subject to magnetism.
- Install this unit onto a level place when possible.

Avoid the following locations for installation.

- Locations exposed to direct sunlight
- Places subject to humidity and with less ventilation
- Places where are extremely hot or cold
- Places subject to vibration
- Places subject to dust
- Places subject to oil, steam, and heat (such as kitchens)

Do not put articles.

Do not put articles on this unit.

To avoid heat emission

Do not place this unit on such device as an amplifier that may emit heat. If the unit is installed on a rack, install the unit below the rack where the amplifier is installed so as to avoid heat emission from the amplifier and other audio devices.

When this unit is installed in a rack with glass doors

While the glass doors are closed, do not open the disc tray by pressing the open/close (⏏) button of the remote control. Disc tray performance will be blocked, and that may result in a malfunction.

Dew condensation

In winter, be careful when carrying this unit from a cold place to a warm place or if the room temperature is suddenly raised by a heater or the like where this unit is installed. The unit interior (operating blocks and lens) will have dew condensation on it. In such a condition, this unit cannot work normally and playback is impossible. This depends on the state of dew condensation, but you will be able to enjoy the music if the unit is left untouched for one to two hours after it has been turned on and the temperature of this unit is maintained at room temperature until the condensation dries.

Even in summer, dew condensation can occur if this unit is directly exposed to cool air from an air conditioner. In such a case, the installation place should be changed.

Batteries

Warning: Batteries used for the remote control shall not be exposed to excessive heat such as sunshine, fire or the like.

How to handle discs

- Do not use any deficient disc (with cracks, warp, etc.).
- Do not damage the signal surface of the disc or make it dirty.
- Do not place paper or a sticker on the disc. They may warp the disc and playback may become impossible. In many cases, rental discs carry labels and paste may protrude from under the label. Before use, check that the disc is free from protruding paste or the like.
- Do not play two discs in a stack.

How to store discs

- Always put your discs in a case. Store them vertically where high temperature, high humidity, and direct exposure to sunlight are not prevalent. Places with extremely low temperature should also be avoided.
- Read the caution notes carefully that are attached to discs.

Disc cleaning

- If a disc is dirty from fingerprints or dust, the sound quality may be lowered. Lightly wipe the disc with soft cloth, from the inside to outer periphery. (Don't wipe it along the circumference.)
- Do not use a volatile chemical such as benzine or thinner. Record spray, anti-static agents, and other such materials cannot be used either.
- Where the disc seems to be very dirty, dip soft cloth in water, wring it well, and remove contaminants. Lastly, remove the moisture with dry cloth.

Disc in a specific shape

This unit cannot accept discs in specific shapes (heart-shaped, hexagonal, etc.) for playback. Never use such discs as they can cause malfunctions.

Lens cleaning

If the lens is dusty, sound skips may take place. Do not use any cleaning discs available on the market because they may hurt the lens.

Cleaning

- Usually, wipe the unit with a dry soft cloth. When the dirt is hard to remove, dip soft cloth in detergent diluted 5 or 6 times with water, wring it well, and remove contaminants. Then, remove the moisture with dry cloth.
- Do not use a solvent like alcohol, benzine, thinner, or pesticide because such a substance can damage the exterior. In addition, do not let this unit contact a rubber or plastic form for a long time. That may damage the cabinet surface of the unit.
- When using a chemical cloth for cleaning, read the caution provided with the chemical cloth product.
- Before cleaning, unplug the power cord from the AC outlet.

Features of This Unit — CD player

Vacuum tube circuit

Single-stage amplification circuit using ECC82 (12AU7).
Low distortion is achieved thanks to P-G feedback from the plate to the grid.
Fine-tuned EI-type output transformer is equipped.

Output switchover function

The output can be selected between the one through the vacuum tube circuit from DAC IC and the one directly connected from the solid-state circuit.

Articulation function

Magnetization of the output transformer that may cause the deterioration of sound quality can be eliminated with use of sound signals to be played back, by pressing the clear button on the remote control.

8 mm thick aluminum base

A machined aluminum base with 8 mm in thickness is used as a base of the CD mechanism. The rigidity of the chassis structure is increased by combining with aluminum front panel.

Jitter-reduction function

This unit is equipped with a circuit to reduce the clock jitter in the system clock.

Zoom function

When the ZOOM switch on the remote control is pressed, the track number and time information can be an enlarged.

4 playback modes

Playback mode can be selected from regular playback, program playback, random playback, and repeat playback.

Dimmer function

The brightness of the display window can be switched over from 4 steps.

Digital output OFF

The digital audio output can be deactivated to improve the quality of analog audio output.

Filter selection function

The filter can be selected from the normal FIR filter or low latency IIR filter.

Last memory function

Built-in flash memory can memorize settings such as dimmer, digital output ON/OFF, and digital filter, etc.

Analog output terminals

Introduction of 18 mm pitch RCA terminals with gold plating allow even high-performance line cables with large plugs to be connected.

PCM5102A manufactured by Burr-Brown

For DAC chip, PCM5102A manufactured by Burr-Brown is used.

Original technologies

Our traditional round pattern board, OFC internal wiring, and original custom-made parts are fully and luxuriously used.

Remote control (RD-26)

The remote control is encased in aluminum. Tactile switches will satisfy users with a real operational feeling.

High-inertia power supply

High-inertia power supply circuit that combines a large-capacity EI-core-type power transformer with tailor-made 3,300 μF x 3 capacitor blocks.

Schottky barrier diode

Application of schottky barrier diode manufactured by Nihon Inter Electronics Corporation that has less switching noises and higher conversion efficiency to the DC voltage for the power supply rectifier circuit.

LUXMAN's original OFC wires





Our original OFC wires are used in the internal wiring to achieve smooth signal transmission thanks to the non-plating process on the core wire.

The described company names and product names are trademarks or registered trademarks of each company.

Discs This Unit Can Play Back

Types of discs that can be played

The following marks are printed on disc labels, packages, or CD jackets.

Types of discs this unit can play back		
		
Types of discs this unit cannot play back		
		

This unit can play back 8 cm CDs without using an adapter.
Do not use an adapter for 8 cm CDs.

- CD-R/CD-RW discs written by a recorder or PC may not be played back (due to characteristics of discs, scratches, dirt on discs, dirt on the lens of the unit, dew condensation, etc.).
- Discs written by a PC may not be played back depending on the application settings or environment. It is recommended writing the discs in a proper format. (Refer to the distributor of application for details.)
- Time information may not be displayed when an unfinalized CD-R/CD-RW disc is played back.
- Refer to the precautions for discs for details on how to handle CD-R/CD-R discs.

Before Use

Check the accessories.

After unpacking, check if the following accessories are not missing.

- Power cable
- Remote control (RD-26)

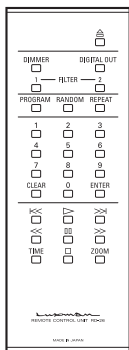

- “AAA” batteries (2 pieces)

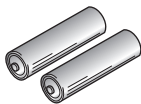

- Safety cautions
- Owner's Manual (This document)

How to Use Remote Control

Insert batteries into the remote control.

1. Remove the battery cover on the rear of the remote control.
Put your finger on the battery cover claw and slide the cover downward to remove the cover.
2. Put 2 AAA batteries in the battery case as shown in the illustration on the battery case in consideration of the polarity \oplus and \ominus .
3. In the reverse order of battery cover removal, put the battery cover back to the opening of the remote control and slide the cover upward until it clicks.

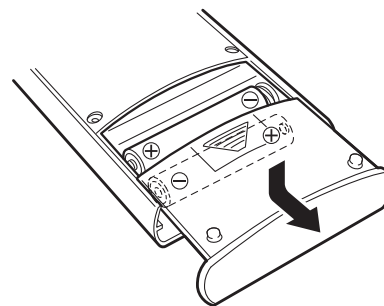

- Do not use a new battery and an old one together.
- There may be a case in which the voltages are different between two batteries even though their shapes are the same. Do not use the batteries of different types together.
- If the remote control is not used for a long time (more than 1 month), the batteries shall be removed from the case. If the battery liquid leaks, wipe away the liquid from the case before inserting new batteries.
- To discard exhausted batteries, follow the instructions of each local authority.

Remote control's range

The remote control can be used by pointing at the remote control infrared receiver on the front panel of main unit. The effective distance is approx. 5 m from the main unit and 30° on both sides from the control infrared receiver.

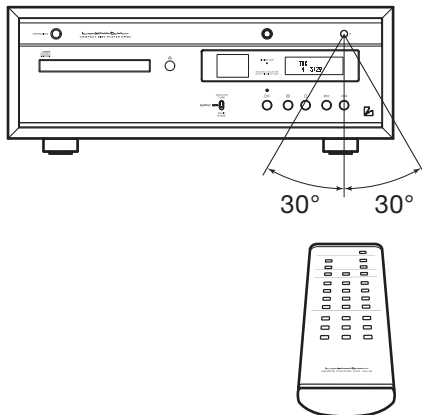

Effective distance:
approx. 5 meters

Do not expose the remote control infrared receiver to direct sunlight or a strong light source. That may cause malfunction.

Names and Functions

Front panel

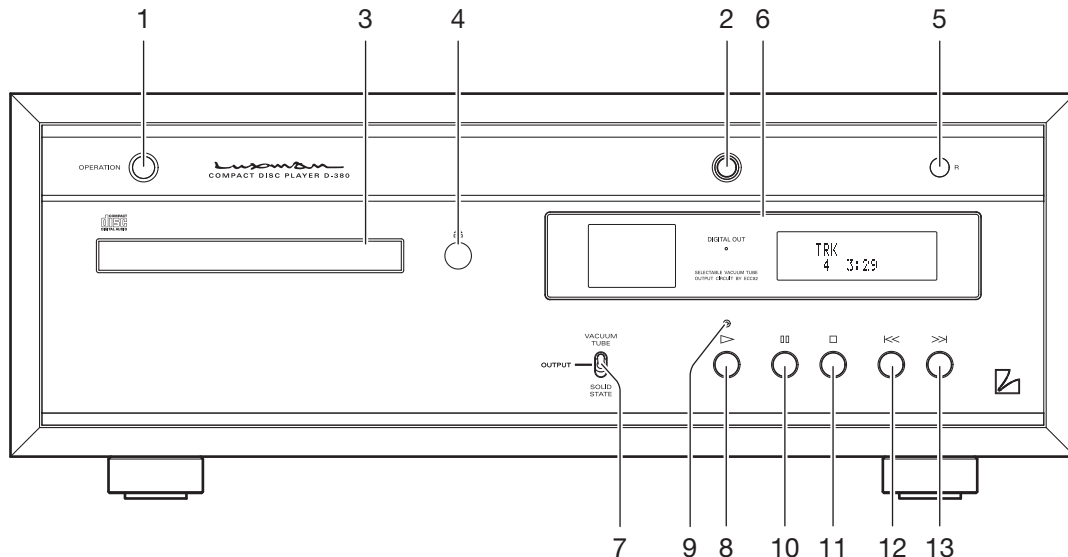

1. Operation switch (OPERATION)

Turns this unit to the operating state.

2. Operation indicator

Blinks during warm-up when the operation switch is turned on and lights up when the operation state is activated afterward.

3. Disc tray

When inserting or removing a disc, this tray is opened or closed by pressing the open/close switch (4).

4. Open/close switch (4)

Opens or closes the disc tray.

5. Remote sensor (R)

Receives signals from the accessory remote control.

6. Display window

Displays the operation status of this unit.

It is composed of LED indicators and FL display tube.

Also, when the vacuum tube output is selected, the back light of the vacuum tube will light up.

7. Vacuum tube output selection switch (OUTPUT)

Changes the analog output circuit.

VACUUM TUBE: Selects the output through the vacuum tube circuit.

SOLID STATE: Directly outputs from the D/A converter IC without vacuum tube circuit.

8. Play switch (▶)

Plays back a disc.

9. Play indicator

Lights up while a disc is being played back. Blinks while playback is being paused.

10. Pause switch (⏸)

When this switch is pressed during playback, the playback stops. When this switch is pressed again, the playback starts again. During pause, the play indicator blinks.

11. Stop switch (⏹)

Stops playback.

12. Previous switch (◀◀)

When this switch is pressed, the playback returns to the beginning of track. When this switch is pressed twice, the playback returns to the beginning of previous track.

13. Next switch (▶▶)

When this switch is pressed, the playback jumps to the beginning of next track.

Display window

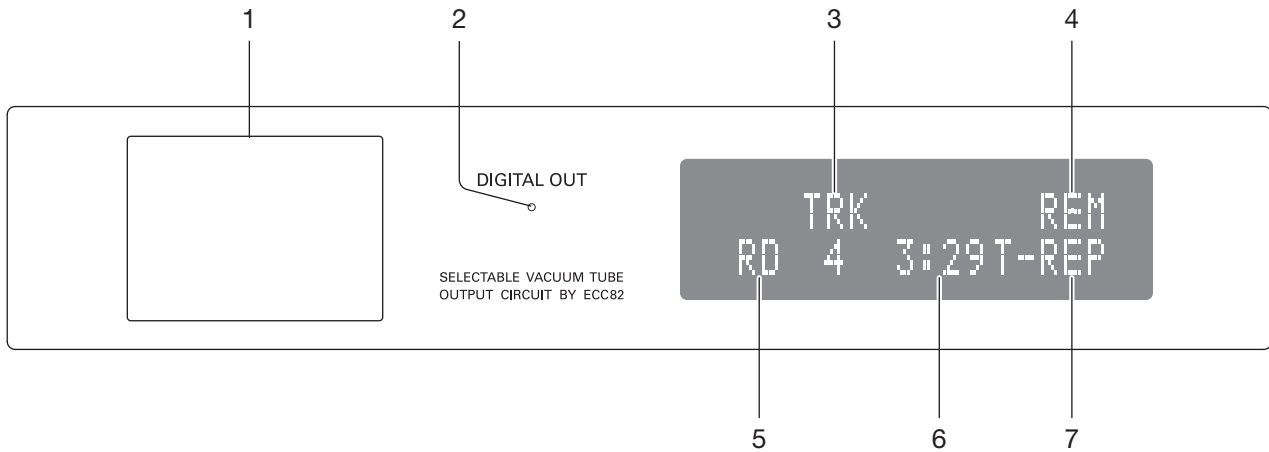

1. Vacuum tube display window

When the vacuum tube output is selected, the back light of the vacuum tube will light up.

2. Digital output indicator (DIGITAL OUT)

Lights up when digital audio output is on.

The on/off of the digital output can be operated by the remote control.

3. Track number (TRK)

"TRK" is indicated on the upper side, and the track number is shown on the lower side when these display area shows the track number.

4. Time display mode

The display mode of time is displayed. "REM" is displayed when showing the remaining time of current track. "T-REM" is displayed when showing the total remaining time of disc. This display area does not light up when showing the elapsed time of track.

5. Playback mode

"RD" is displayed during random playback. "PG" is displayed during program playback. This display area does not light up during regular playback.

6. Time

Displays the elapsed time of current track, remaining time of current track, or remaining time of disc. Time display is switched over according to time display mode.

7. Repeat mode

Displays the mode for repeat playback. There are two types of repeat playback: track repeat (T-REP) and all repeat (A-REP).

Names and Functions

Remote control

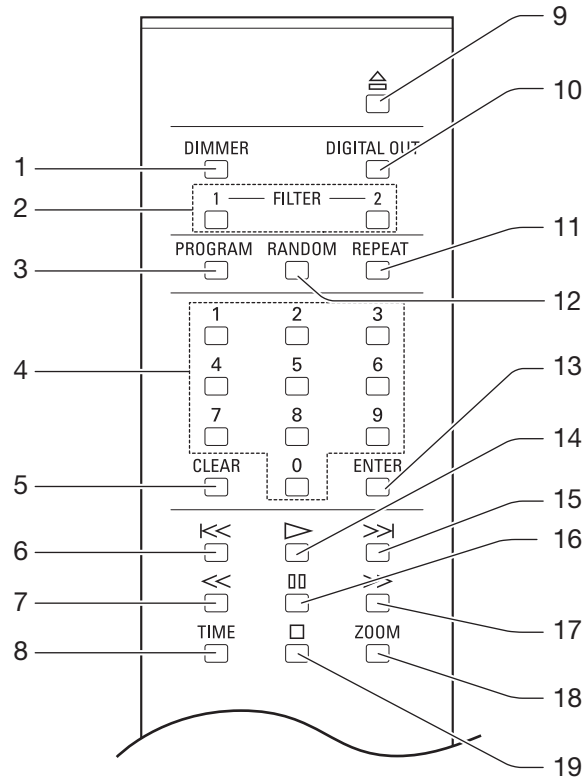

1. Dimmer switch (DIMMER)

Adjusts the brightness of the main unit display window. The brightness can be adjusted in 4 steps from light off to normal.

2. Digital filter selection switch (FILTER)

This switch changes the interpolation function of the 32-bit digital filter. Select a filter depending on your taste. The sound quality can be changed.

There are two types of filters, and the impulse response of the interpolation function is shown in the diagrams on the right.

This setting is stored on the flash memory even when the power is turned off.

F-1 (normal FIR filter)

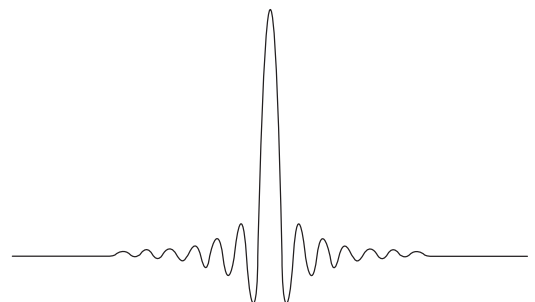

F-2 (low latency IIR filter)

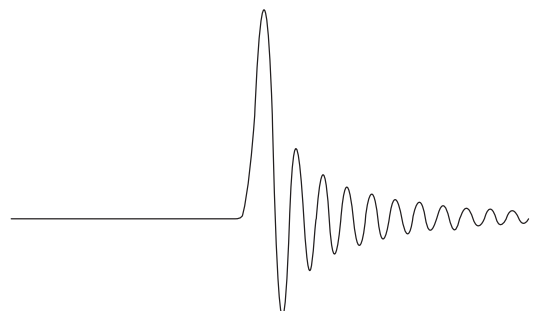

3. Program switch (PROGRAM)

Programs the track numbers to play back in a desired order.

4. Numeric keys (1, 2, 3, 4, 5, 6, 7, 8, 9, 0)

These keys are pressed to specify the track numbers for direct search or program.

5. Clear switch (CLEAR)

Cancels the program settings. Also, if this switch is pressed for approximately 3 seconds while vacuum tube output is played back, the articulation function (page 16) will be enabled.

6. Previous switch (⏮)

When this switch is pressed, the playback returns to the beginning of track. When this switch is pressed twice, the playback returns to the beginning of previous track.

7. Rewind switch (⏪)

When this switch is played during playback, audio is re-wound.

8. Time display switch (TIME)

Switches the time display. Switches the elapsed time of current track, remaining time of current track, or remaining time of disc.

9. Open/close switch (⏏)

Opens or closes the disc tray.

10. Digital output selection switch (DIGITAL OUT)

A switch to toggle between on and off of digital output (COAX/OPT).

11. Repeat switch (REPEAT)

This switch is pressed to perform repeat playback. There are two types of repeat playback: track repeat (T-REP) and all repeat (A-REP).

12. Random switch (RANDOM)

This switch is pressed to perform random playback.

13. Enter switch (ENTER)

Executes the set or selected items.

14. Play switch (▶)

Plays back a disc.

15. Next switch (▶▶)

When this switch is pressed, the playback jumps to the beginning of next track.

16. Pause switch (⏸)

When this switch is pressed during playback, the playback stops. When this switch is pressed again, the playback starts again. During pause, the play indicator blinks.

17. Fast-forward switch (▶▶▶)

When this switch is played during playback, audio is fast-forwarded.

18. Zoom switch (ZOOM)

When this switch is pressed during playback, the track number and time are displayed in an enlarged manner.

19. Stop switch (⏹)

Stops playback.

Names and Functions

Rear panel

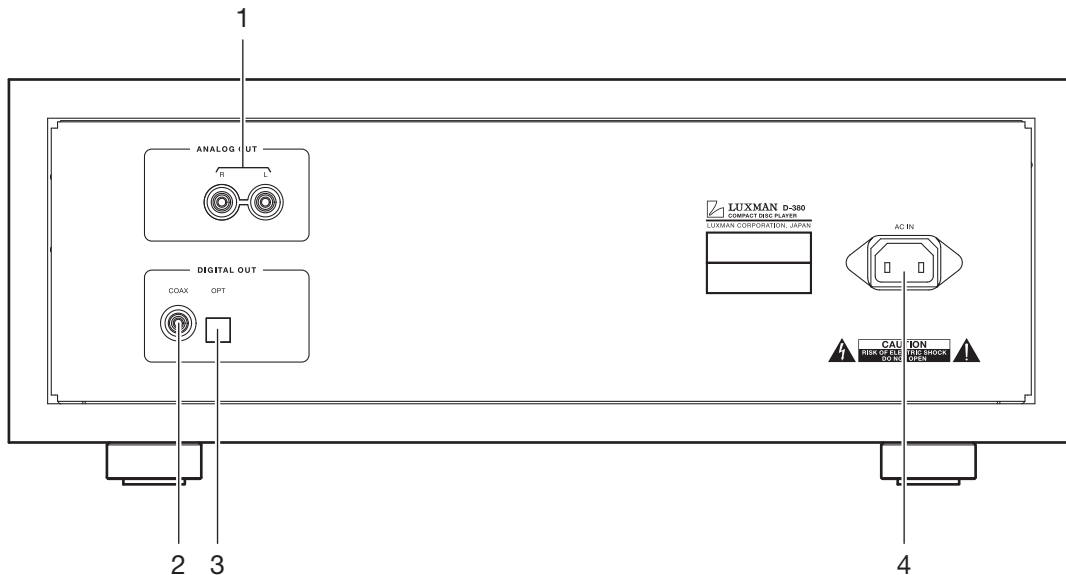

1. Analog unbalance output terminals (ANALOG OUT)

Coaxial output terminals to provide unbalanced playback signals of this unit.

Connect these terminals to an unbalanced input of such device as an integrated amplifier with a pin cable.

2. Coaxial digital output terminal (COAX)

This terminal is connected to an amplifier that has a digital input terminal using a coaxial digital cable.

3. Optical digital output terminal (OPT)

Connect this terminal to such device as an amplifier that has a digital input terminal using an optical digital cable.

This terminal is a shutter-type. Direct the cable connector correctly when inserting the cable into the terminal. If the cable connector is inserted forcibly to the wrong direction, the terminal may be deformed, and the shutter may not be able to close even after cable disconnection.

4. Power cable terminal (AC IN)

Connect the accessory power cable to supply the power from the AC outlet on the wall.



Note:

This symbol represents CLASS II apparatus without functional earth.

Connections

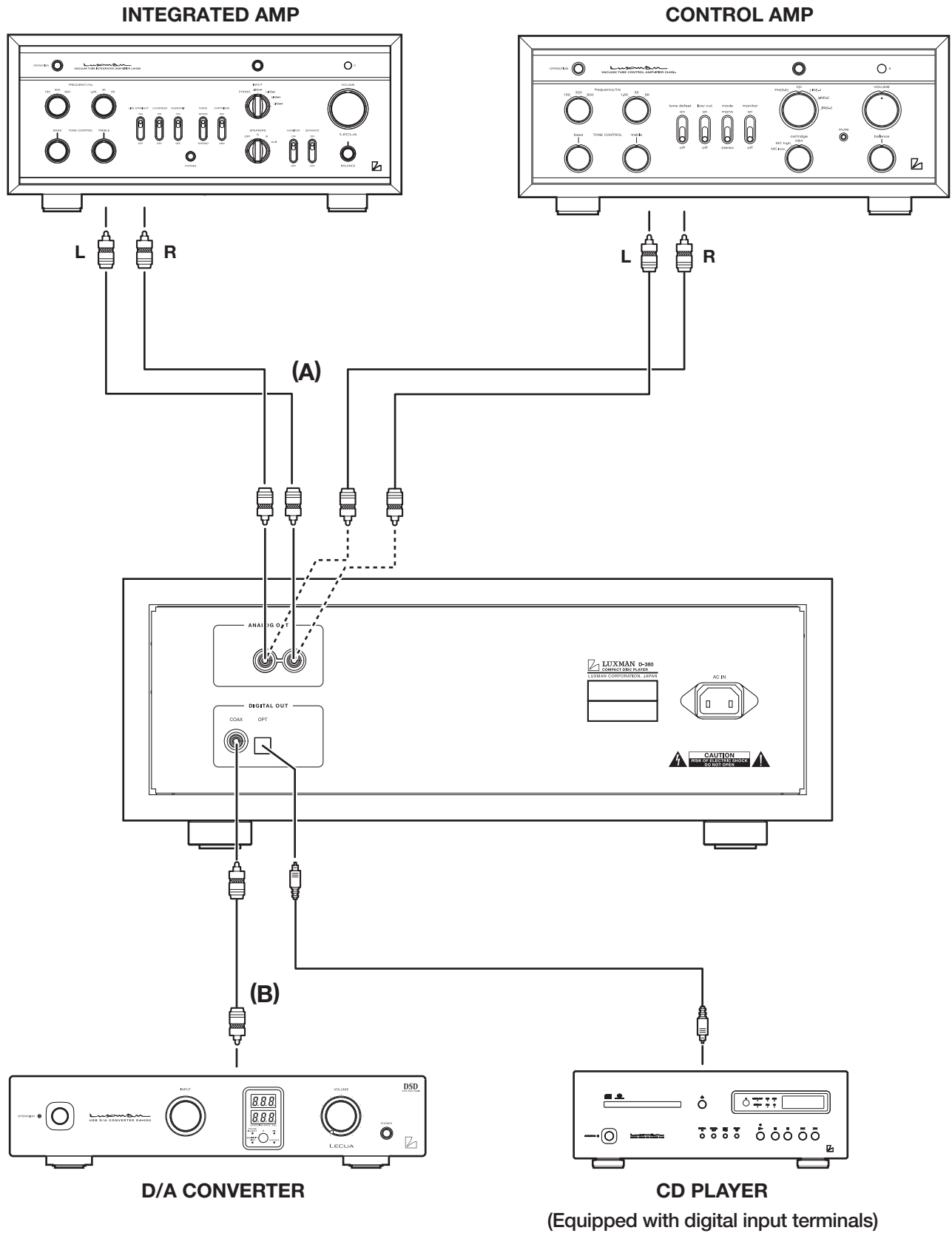

Before connecting

Before connecting other devices, connect the jack side of the accessory power cable to the AC inlet of this unit.

When connecting, turn off the power supply of this unit and the power supplies of auxiliary devices to prevent unexpected accidents that may be caused by noise.

How to connect power supply

Use the accessory power cable to insert the AC plug in an outlet on the wall in the listening room.

How to connect output devices

1. Unbalanced connection with such device as an integrated amplifier (Refer to the connection diagram (A).)

Connect between the analog unbalanced output terminals of this unit and the unbalanced input terminals of such device as an integrated amplifier amplifier with 2 (R and L) pin-plug cables.

2. Digital output to such device as another D/A converter (Refer to the connection diagram (B).)

Connect between digital output terminal (COAX/OPT) of this unit and such devices as a D/A converter and a CD player equipped with digital input terminals with a coaxial digital cable or an optical digital cable.

This terminal is a shutter-type. Direct the cable connector correctly when inserting the cable into the terminal. If the cable connector is inserted forcibly to the wrong direction, the terminal may be deformed, and the shutter may not be able to close even after cable disconnection.

Upper side



Lower side

The optical terminal is directed as illustrated.

How to Play Back Discs

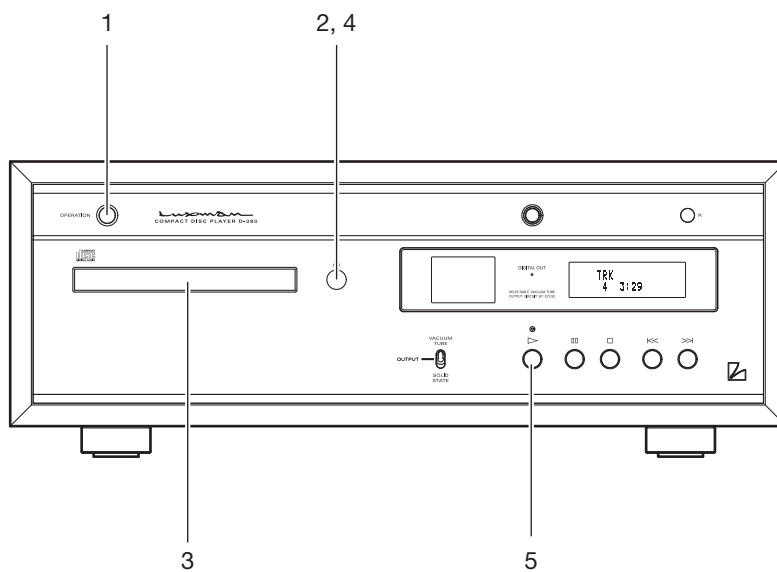
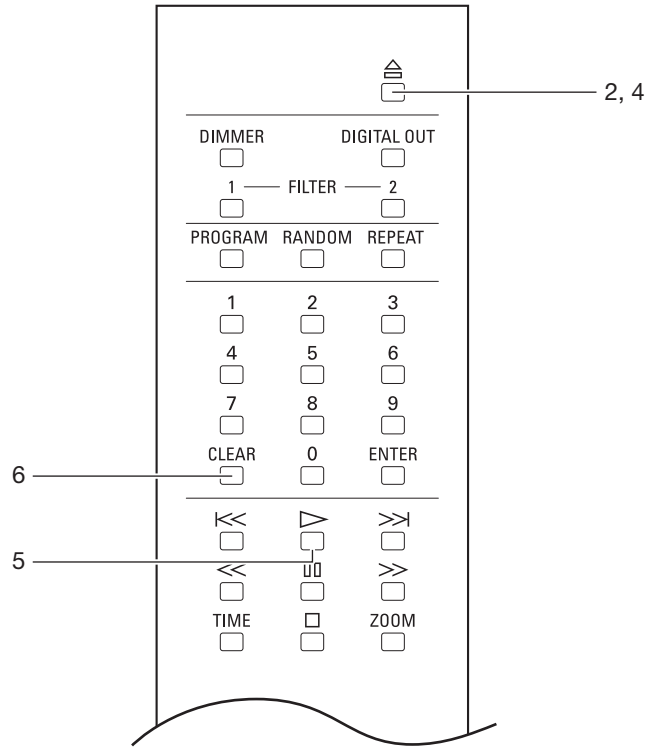

Playback a disc



1. Press the OPERATION switch.

“-OPERATION-” appears on the display window. When the indication disappears, the unit becomes operable.

When the vacuum tube output is selected, “VACUUM TUBE WARMING UP” is displayed on the display window and it counts down in seconds the time to become operable. (Approx. 30 seconds)

This warm-up time represents the time required for the heater of the vacuum tube to be warmed up and the bias to be stabilized. During this time, operation other than open/close (⏮) is disabled.

To operate the unit instantly, choose the solid-state output.

2. Press the open/close (⏮) switch.

The disc tray opens.

3. Put the disc on the disc tray according to the guide on the tray.

4. Press the open/close (⏮) switch.

The disc tray closes and the disc is loaded.

To start playback quickly, press the play (▶) switch without pressing the open/close (⏮) switch.

Or select a track by pressing a numeric key without pressing the open/close (⏮) switch, and press the ENTER switch or play (▶) switch.

Operation switches and numeric keys are not functional during the period from disc loading to displaying of disc type. Specifying the next operation, for example specifying the number of tracks beforehand, can shorten the time before playback start.

5. Press the play (▶) switch.

There is a difference in sound volume. When vacuum tube output is selected, the output voltage is 2.4 Vrms. When solid state is selected, the output voltage is 2.1 Vrms.

Articulation function



6. Press the CLEAR switch (approximately for 3 seconds) during playback of vacuum tube output.

During demagnetization, “ARTICULATOR” is displayed on the display window, and the sound signal output will be turned off. Then, the regular playback resumes after approximately 15 seconds.

Stop/pause the Playback

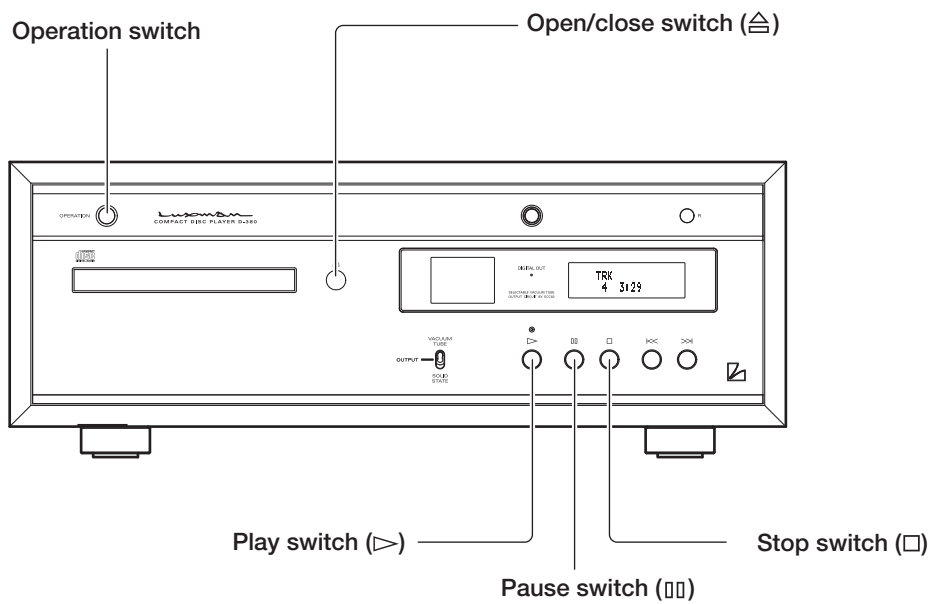
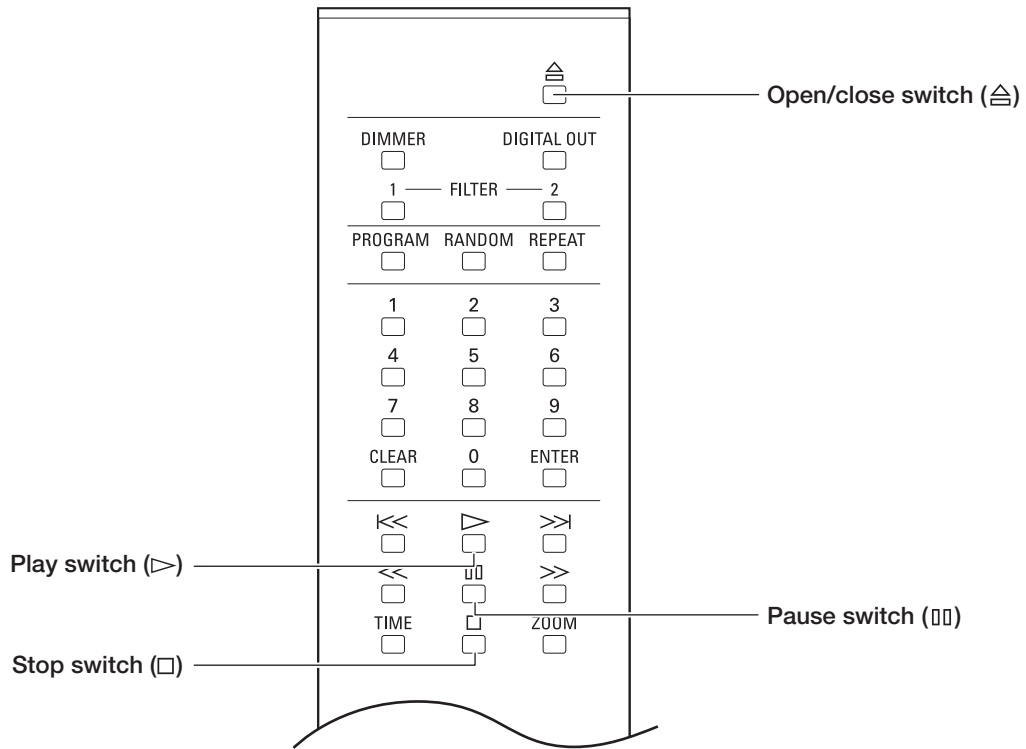

Pause/stop the playback of the disc



How to pause playback

1. Press the pause (⏸) switch during playback.

During pause, the play indicator blinks.

Resumes the regular playback

2. Press the play (▶) or pause (⏸) switch during playback.

Stop the playback

Press the stop (⏹) switch during playback.

Eject a disc

Press the open/close (⏏) switch.

The disc tray opens.

Turn off the power

Press the OPERATION switch.

Skip/Fast-forward/Rewind

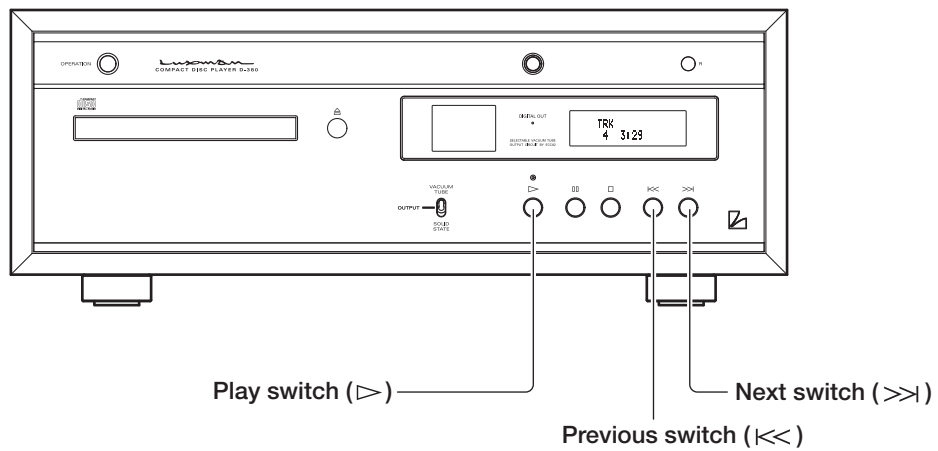
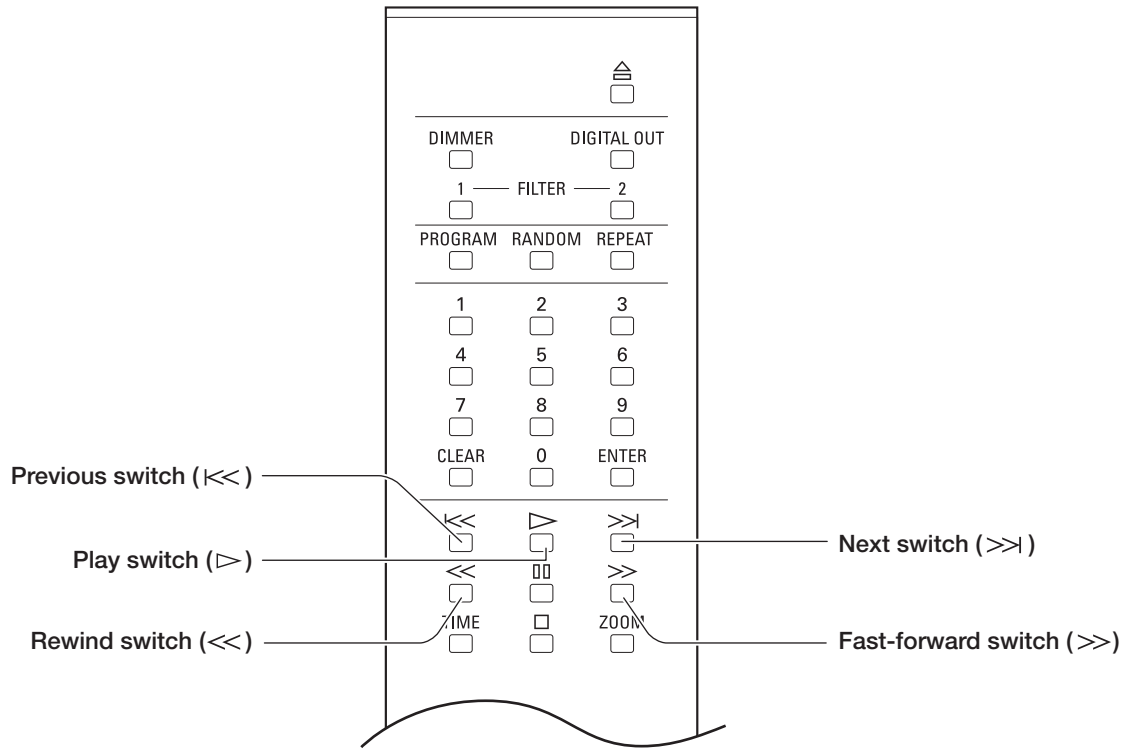

Skips to the desired track (cue function)



Skip playback

Skip to the track to play back.

To skip to the track to play back, press the next switch (>>>) repeatedly until the desired track is displayed.

Go back to the track to play back.

To go back to the track to play back, press the previous switch (<<) repeatedly until the desired track is displayed. When this switch is pressed once, the playback returns to the beginning of current track. When this switch is pressed twice, the playback returns to the beginning of previous track.

Fast-forward/rewind the playback (scan)



Fast-forward the playback

1. During playback, press the fast-forward (>>) switch.

Each time the switch is pressed, the rewind speed can be changed in 3 steps.

">>1, >>2, >>3" appears on the display to indicate the fast-forward state and speed.

2. To resume the regular playback, press the play (▷) switch.

Rewind the playback

1. During playback, press the rewind (<<) switch.

Each time the switch is pressed, the rewind speed can be changed in 3 steps.

"<<1, <<2, <<3" appears on the display to indicate the fast-rewind state and speed.

2. To resume the regular playback, press the play (▷) switch.

Direct search/repeated playback

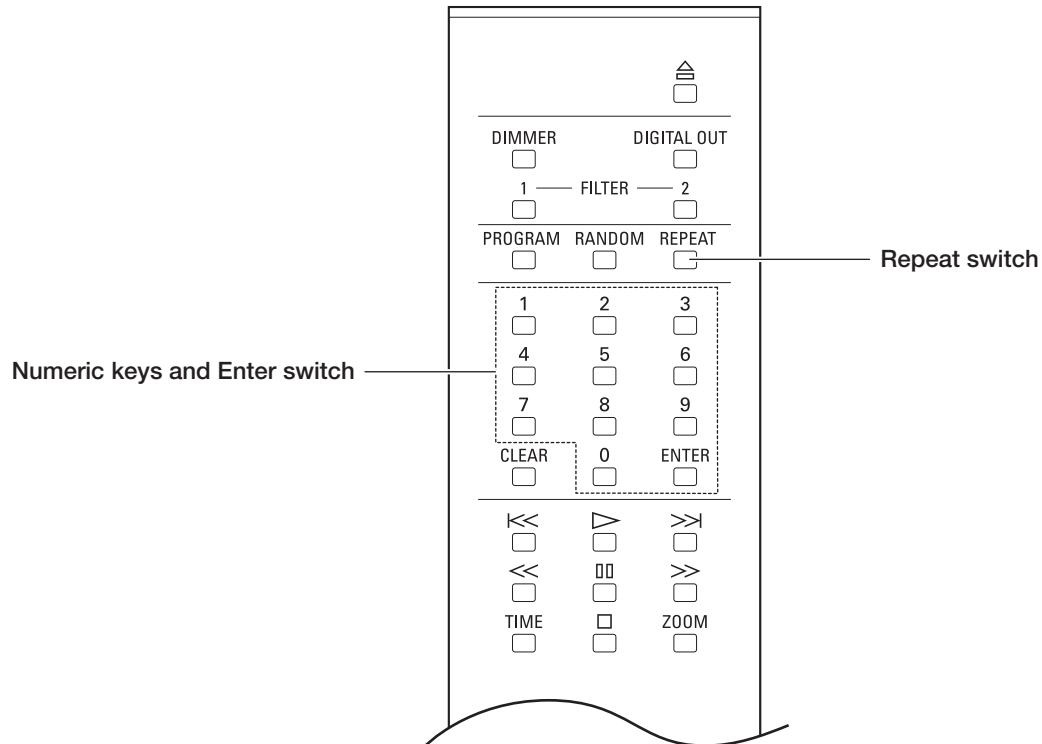

Specify the desired track for playback

Remote control

1. Enter a track number by pressing numeric keys.

For example, when selecting the 15th track, press the “1” key, and then “5”.

2. Press the ENTER or play switch.

Playback is started automatically even without pressing the ENTER key after the elapse of approx. 3 seconds. The maximum number of tracks is 99 for a CD, and it may take longer time to enter a 2-digit track number. For this reason, approximately 3 seconds are given to CDs before auto jump.

Play back repeatedly (Repeat playback)

Remote control

There are two types of repeat playback:
track repeat (T-REP) and all repeat (A-REP)

Track repeat (T-REP)

1. During playback, press the REPEAT switch once.
2. "T-REP" appears on the display window to indicate the track repeat.
3. When this switch is pressed twice again, the track repeat is canceled.

Repeated playback is also canceled when the disc is stopped.

All repeat (A-REP)

1. During playback, press the REPEAT switch twice.
2. "A-REP" appears on the display window to indicate all repeat.
3. When this switch is pressed once again, the track repeat is canceled.
Repeated playback is also canceled when the disc is stopped.

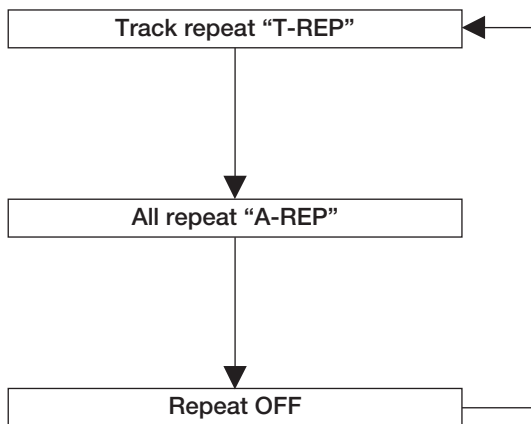

Program Playback

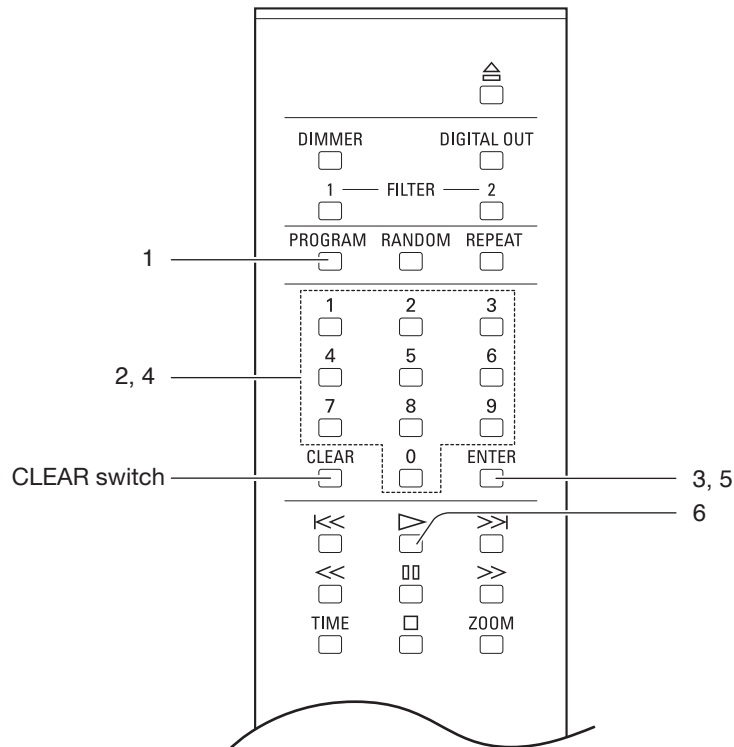

Play back the tracks in a programmed order (Program playback)

Remote control

It is possible to program up to 24 tracks in the desired order.

1. During stop, press the PROGRAM switch.

The following indication appears on the display window.

```

    T-TIME
PG 00  00:00
  
```

2. Enter a desired track number by pressing numeric keys of the remote control.

For example, when selecting the 5th track, press the "5" key.

```

PG 01      5
  
```

3. Press the ENTER switch.

The order of the track is determined, and then track number and total time appear on the display.

```

    T-TIME
PG 01  01:28
  
```

4. Enter the track number to program next.

For example, when selecting the 15th track, press the "1" key, and then "5".



5. Press the ENTER switch.

The order of the track is determined, and then track number and total time appear on the display.



Program the desired tracks by repeating Step 2 and 3.

6. Press the play (▷) switch.



- When pressing the CLEAR switch during stop, the entire program is deleted.
- When pressing the PROGRAM switch, and then the CLEAR switch during stop, the last programmed track will be deleted.
- It is impossible to program "pause".
- When pressing the REPEAT switch during program playback, all the tracks will be repeated in the programmed order.
- Track repeat is not available during program playback.
- When pressing the next (>>) switch during program playback, the playback jumps to the track programmed next.
- To perform the program playback again, press the PROGRAM switch during stop, and then the play (▷) switch.

Procedure

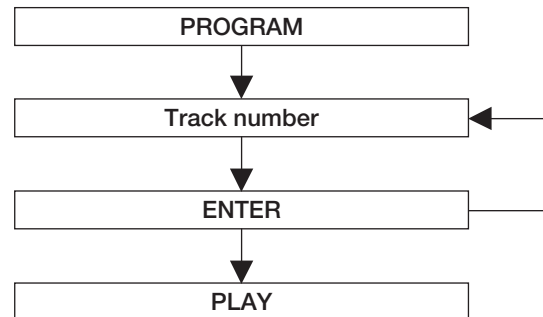

Random playback/disc information/zoom

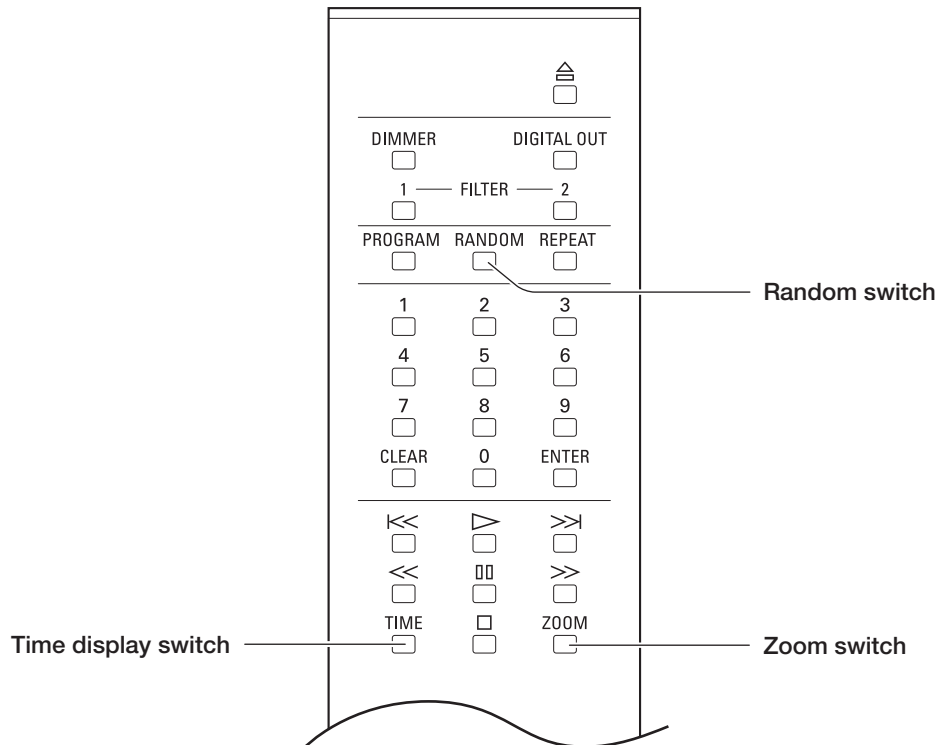

Play back the tracks in a random order (Random playback)

Remote control

Each track is selected from all the tracks and is played back once.

1. Press the RANDOM switch.

2. "RD" appears on the display window to indicate the random playback. The playback stops automatically after all the tracks are played back.

Random playback stops when a disc is stopped or the RANDOM switch is pressed once again. When pressing the next (>>|) switch during random playback, the next track is randomly selected and played back. When pressing the previous (|<<) switch, the playback returns to the beginning of current track.

Disc information

Remote control

Switch the time display during playback.

Each time the TIME display switch is pressed during playback, the display changes as follows.

1. The current track number and the elapsed time of the track (In the default setting)

"TRK" will appear on the display window.

2. The current track number and the remaining time of the track (Remain)

"TRK" and "REM" will appear on the display window.

3. The total remaining time of the disc (Total remain):

"T-REM" will appear on the display window.

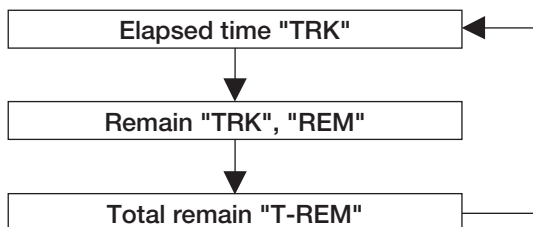

Zoomed display

Remote control

Enlargement of displayed characters

1. Pressing the ZOOM switch makes the displayed track number and time larger.
2. When pressing the ZOOM switch once again, the display returns to the normal state.

Normal display

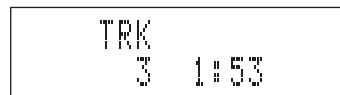

Zoomed display

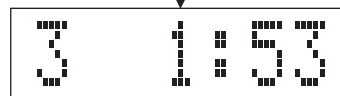

Detailed Settings

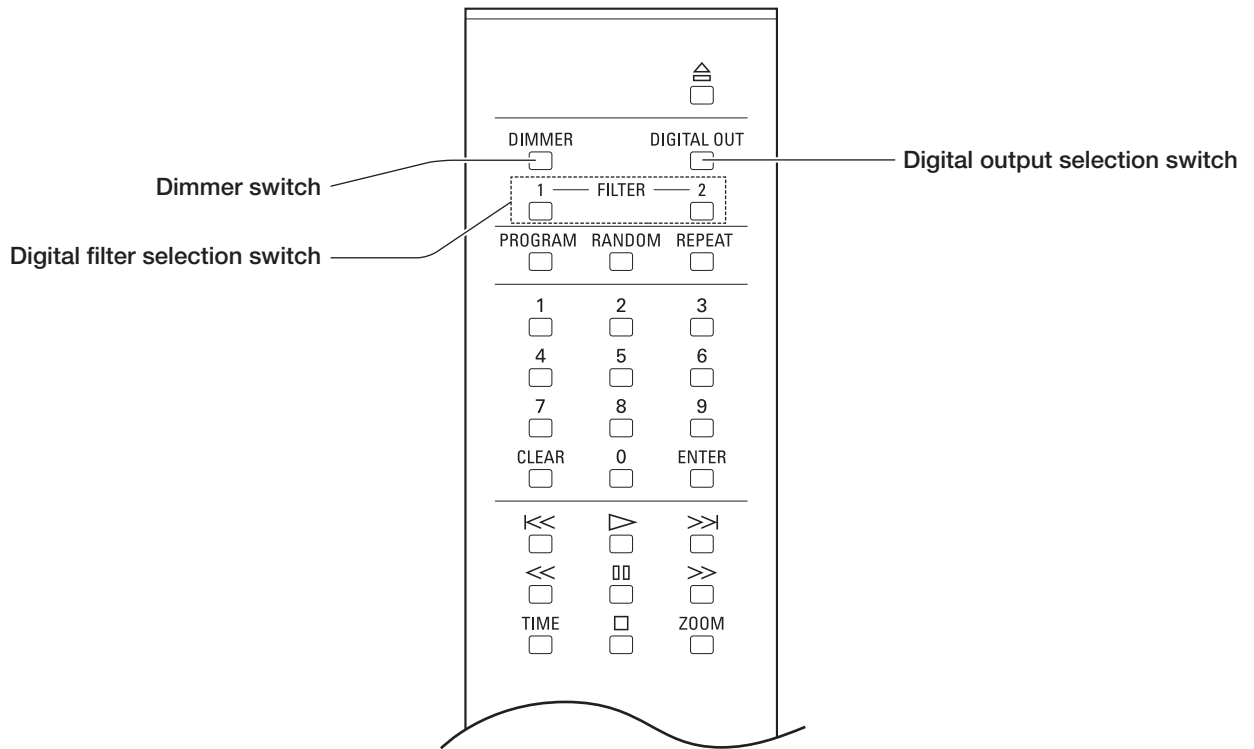

Operation switch

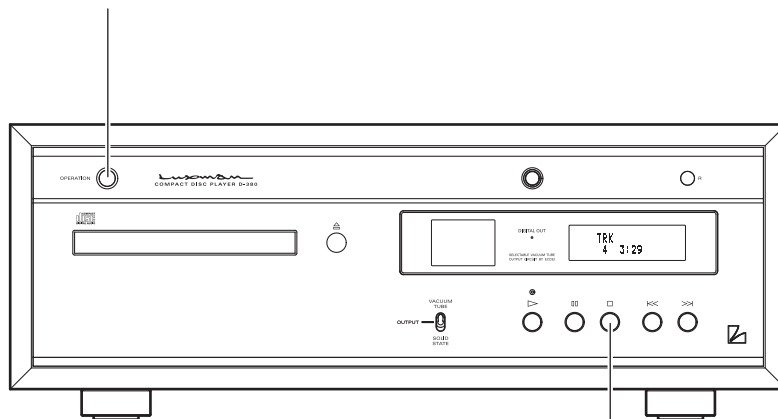

Stop switch

Dimmer switch (DIMMER)

Remote control

The brightness of the main unit display window can be adjusted. The brightness can be adjusted in 4 steps from light off to normal.

Each time the DIMMER switch is pressed, the display changes as follows. Normal light → Dim → Very dim → Light off → Normal light → ...

Selection of light off displays "DISPLAY OFF" for 2 second and the sign turns off.

It is impossible to change the brightness of LED indicator.

Digital filter selection switch (FILTER 1, 2)

Remote control

Select a filter from two types according to your taste.

Pressing FILTER 1 displays "F-1 NORMAL FIR" on the display window.

Pressing FILTER 2 displays "F-2 LOW LATENCY" on the display window.

Digital output selection switch (DIGITAL OUT)

Remote control

A switch to toggle between on and off of digital output (COAX/OPT). When off is selected, the LED indicator will be turned off.

Restore all the settings to the factory defaults.

All the settings are restored to the factory defaults.

Press the OPERATION switch on the main unit while pressing the stop (□) switch on the main unit.

All the settings are restored to the factory defaults.

Item	Default
Digital output selection	on
Dimmer adjustment	Normal
Digital filter	F-1
Zoomed display	Normal

Last memory function (Memorization of each setting)

The following are the setting items to be memorized on the flash memory.

When the power is turned off immediately after setting change, the setting data may not be successfully memorized.

Item	Selection
Digital output selection	on, off
Dimmer adjustment	Normal, Dim, Very dim, Light off
Digital filter	F-1, F-2
Zoomed display	Zoomed, Normal

Block Diagram

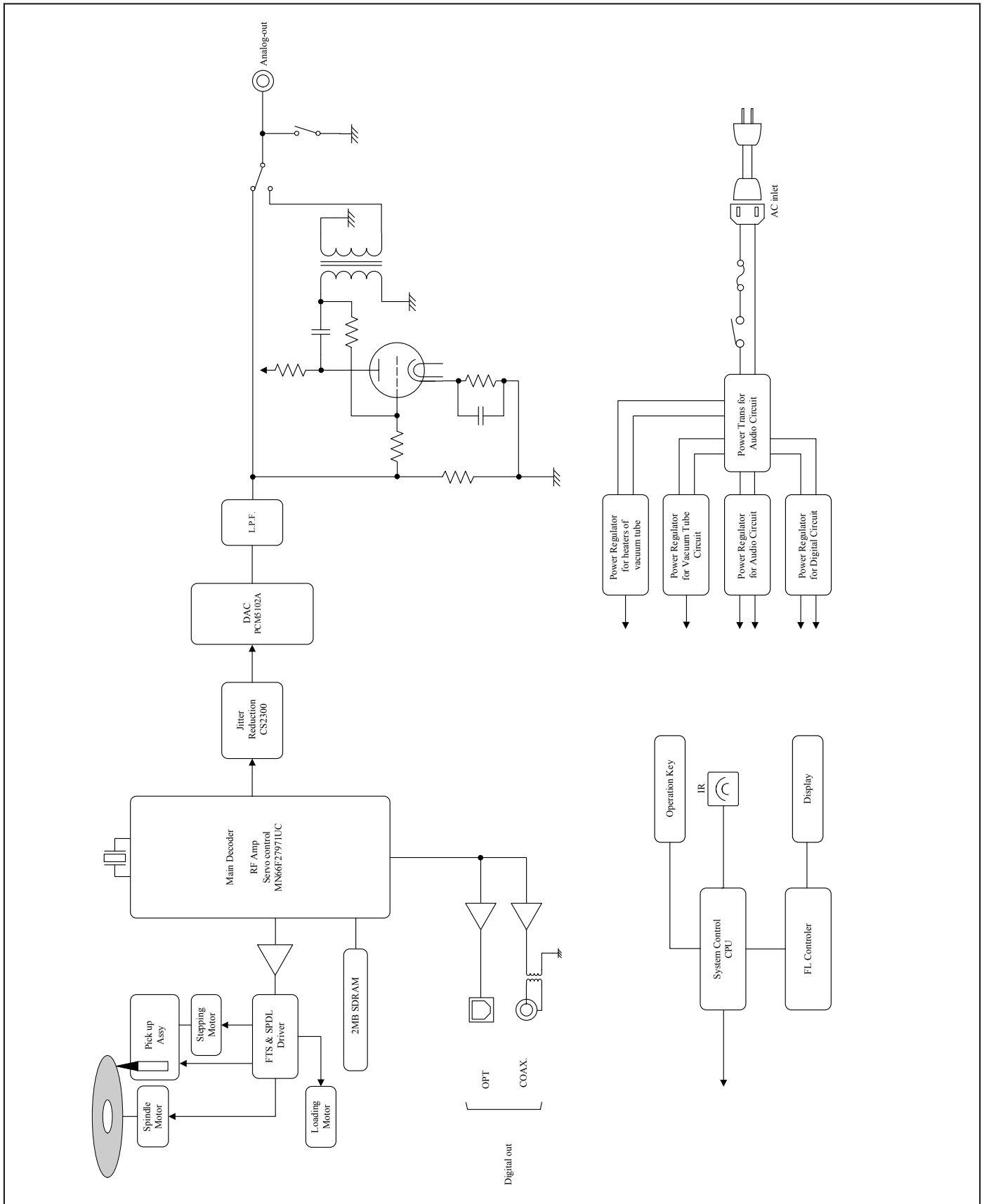

Specifications

luxman
COMPACT DISC PLAYER D-380

Format	2-channel CD		
Power supply	230 V ~ (50 Hz)		
Power consumption	16 W		
Weight	10.8 kg (main unit)		
Max. external dimensions	440 (W) x 167 (H) x 286 (D) mm (front side knob of 4 mm and rear side terminal of 8 mm included in depth)		
Ambient operating temperature / Ambient operating humidity	+5 °C to +35 °C / 5 % to 85 % (non condensing)		
Audio output characteristics	Output voltage /	VACUUM TUBE	2.4 Vrms/300 Ω
	Output impedance:	SOLID STATE	2.1 Vrms/300 Ω
	Frequency response:	VACUUM TUBE	20 Hz to 20 kHz (+0.1, -0.3 dB)
		SOLID STATE	20 Hz to 20 kHz (+0, -0.2 dB)
	Total harmonic distortion:	VACUUM TUBE	0.8 %
		SOLID STATE	0.005 %
	S/N ratio:	VACUUM TUBE	105 dB
		SOLID STATE	115 dB
	Dynamic range:	VACUUM TUBE	98 dB
		SOLID STATE	119 dB
Channel separation:	VACUUM TUBE	58 dB	
	SOLID STATE	82 dB	
Digital output	Coaxial digital output:	RCA terminal 0.5 Vp-p/75 Ω	
	Optical digital output:	Optical digital terminal -15 to -21 dBm	

* Specifications and appearance are subject to change without notice.

Before Asking for Repair Service

While the unit is used, an unusual phenomenon may be confused as a malfunction for a certain reason. Prior to asking our official sole distributor of your country for repair services, please check the table below and read the operating instructions for the subsidiary devices. If the cause of the malfunction cannot be identified, please contact your dealer. When we have once accepted your request for repair services, inspection fees and traveling expenses may be claimed even though the unit is found to be normal.

Problem	Cause/Solution	Ref. page
No power is supplied even though the main power switch is pressed.	<ul style="list-style-type: none"> • Connect the power cable to the AC inlet and the AC outlet firmly. 	14
The disc tray comes out even after the tray is closed.	<ul style="list-style-type: none"> • Set the disc on the disc tray correctly. 	16
	<ul style="list-style-type: none"> • Clean the disc to remove dirt. 	2
Playback cannot be performed.	<ul style="list-style-type: none"> • Clean the disc to remove dirt. 	2
	<ul style="list-style-type: none"> • Set the disc on the disc tray correctly. 	16
	<ul style="list-style-type: none"> • Remove dew condensation from the interior of this unit. 	1
	<ul style="list-style-type: none"> • Put the disc on the tray with the label facing upwards. (label face upward) 	
The remote control cannot be operated.	<ul style="list-style-type: none"> • Operate the remote control within the specified operating range. 	6
	<ul style="list-style-type: none"> • Replace the remote control battery with a new one. 	5
	<ul style="list-style-type: none"> • The remote control infrared receiver is exposed to direct sunlight or strong light sources (such as inverter fluorescent lights). Change the installation place or angle to avoid the exposure to light sources. 	6
An electronic device such as a television malfunctions.	<ul style="list-style-type: none"> • Some devices equipped with a wireless remote control receiver may malfunction when the remote control of this unit is operated. Keep this unit away from such devices. 	
No sound is generated from the speakers, or sound is distorted.	<ul style="list-style-type: none"> • Confirm that the connections of audio cables are correct. 	13 - 14
	<ul style="list-style-type: none"> • If a digital output device is connected to this unit, set [Digital output] to [On]. 	10
	<ul style="list-style-type: none"> • Clean the disc to remove dirt. 	2
	<ul style="list-style-type: none"> • When the output level of an amplifier, etc. is minimum, adjust the volume. 	
	<ul style="list-style-type: none"> • Confirm that the cable connectors are connected and firmly inserted into the terminals of the unit. 	
	<ul style="list-style-type: none"> • Clean the cable connectors and terminals by using a plain dry cloth or a cloth dipped in a small amount of dehydrated alcohol. 	
Digital audio signals cannot be output digitally.	<ul style="list-style-type: none"> • Set [Digital output] to [On]. 	10

This unit may not work normally when the unit is subject to external influence such as static electricity. In such a case, normal operation may resume by turning off the power once and turning on the power again after several tens of seconds or returning the unit to the factory setting. If the problem is not solved, please contact your dealer or our service center.

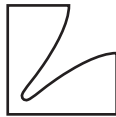

LUXMAN CORPORATION, JAPAN

1-3-1 Shinyokohama, Kouhoku-ku, Yokohama-shi, Kanagawa 222-0033, Japan

AG00987E61A
Printed in Japan