

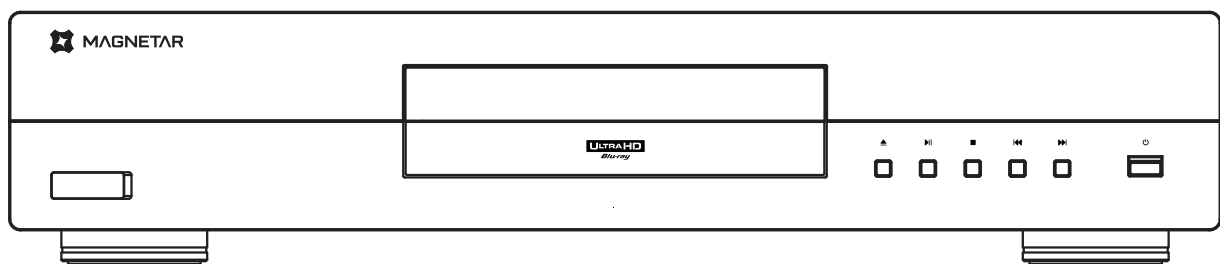

## Ultra HD Blu-ray Disc™ Player

# User Manual

Model: UDP800



# Contents

<b>Important Information .....</b>	<b>1</b>
Important Safety Instructions .....	1
Instructions .....	2
Accessories .....	2
Trademark Descriptions.....	3
Cinavia Notice .....	3
Types of Compatible Discs .....	4
Storage and Maintenance of Compact Discs .....	4
<b>Product Installation Guide .....</b>	<b>5</b>
Functions of Front Panel.....	5
Display Window of Front Panel.....	5
Ports of Rear Panel .....	6
Descriptions of Remote Control .....	7
Battery Installation.....	8
Use of Remote Control .....	8
<b>Common Connections .....</b>	<b>9</b>
Connecting to an A/V Receiver via HDMI.....	9
Connecting to a TV via HDMI .....	10
Connecting to a TV and an A/V Receiver via Dual HDMI .....	11
Connecting to a Stereo System via RCA .....	12
Connecting to a Stereo System Using an XLR Balanced Audio Cable .....	13
Connecting to an Amplifier through S/PDIF (Optical/Coaxial) .....	14
Connecting to the Internet .....	15
BD-Live .....	16
<b>Basic Operations .....</b>	<b>17</b>
Disc Playback .....	17
Option Menu.....	17
Fast Forward and Reverse .....	18
Slow Playback .....	18
Pause and Frame-by-frame Playing.....	19
Blu-ray Disc Menu .....	19
Audio Control .....	19
Mute.....	20
Track Selection .....	20
Subtitle Selection.....	20
<b>Advanced Operations.....</b>	<b>21</b>
Repeated Playback.....	21
Repeat Choosing a Segment .....	21
Pure Audio Mode.....	22
Zooming and Display Ratio.....	22
Memory and Automatic Resume .....	23

Playback by Track Number .....	23
<b>Media File Playback.....</b>	<b>24</b>
Playback from USB Storage Devices .....	24
Main Menu .....	25
Play Music Files .....	26
Play Movie Files.....	27
Viewing Photo Files.....	28
Add Background Music.....	28
Playback from a Home Network .....	29
<b>Setup Menu Options.....</b>	<b>30</b>
Use the Setup Menu.....	30
Display Setup.....	30
TV Screen .....	31
TV System .....	32
Resolution.....	31
HDR Setting .....	32
Dolby Vision Mode.....	32
Color Space.....	32
Deep Color.....	32
3D .....	32
Audio Setup .....	33
Spdif.....	33
HDMI.....	33
Max Sampling Frequency.....	33
DRC .....	34
SACD Output .....	34
SACD Priority .....	34
DVD Audio Mode.....	34
Playback Setup .....	35
Disc Auto Playback.....	35
Closed Caption.....	35
Angle Mark .....	35
PIP Mark .....	35
Second Audio Mark .....	35
Last Memory.....	35
Disc External Subtitles .....	35
Network Setup .....	37
Internet Connection .....	37
Information .....	37
Connection Test .....	38
IP Address Setting.....	37
BD-Live Connection.....	38
DLNA .....	38
Security Setup.....	39

Change Password.....	39
Parental Control.....	39
Country Code.....	39
Language Setup .....	40
OSD .....	40
Menu.....	40
Audio .....	40
Subtitle.....	40
Other Setup.....	40
Screen Saver .....	41
Auto Power Off.....	41
HDMI CEC.....	41
Settings Management.....	41
Load Default.....	41
Update.....	42
BUDA.....	42
About Player.....	42
<b>Other Data.....</b>	<b>43</b>
Troubleshooting .....	43
Product Specifications and Parameters.....	45
<b>RS-232 Control Protocol.....</b>	<b>46</b>
Communication Configuration .....	46
Command Structure .....	46
Response Structure .....	46
Commands .....	47

# Important Information



Notes: To avoid electric shock, please don't open the machine casing. This product excludes user-repairable components. Please have this product repaired by a professional.



The triangular arrow-headed lightning flash icon signifies that inside the product, there is uninsulated "dangerous voltage", which readily causes electric shock.



The triangular icon with an exclamation mark purports to remind users that important operating and maintenance (repair) instructions are hereby introduced.

## Caution:

To avoid fire or electric shock, please don't expose this product to rain or humid environment. Inside the product, high voltage exists. Don't open the casing. Please have the product maintained by a professional. Avoid splashing water on this product. Don't place any object containing liquid (e.g. vase) on this product.

## Important Safety Instructions

1. Please carefully read the following instructions.
2. Follow these safety instructions.
3. Pay attention to all cautions.
4. Observe all reminders.
5. Please don't use this product near water.
6. Please clean this product with dry cloth.
7. Please don't block the vent. Please assemble this product according to the manufacturer's requirements.
8. Don't assemble this product near heat sources (e.g. heat sink, hot air outlet and stove) or other heating equipment (including power amplifier).
9. Please do use original plug. If pins are not

matched with socket, please contact a technician for replacement.

10. Please avoid trampling on or extruding the power cord, especially plug, socket and outgoing parts of this product.

## Notes:

- Incorrect battery installation might cause explosion hazards. Identical or similar types of batteries must be used.
- This product uses laser. Your failure to control or adjust according to this manual or your failure to operate as per steps might cause your exposure to radiation. Please don't remove the cover or repair this product by yourself. This product must be repaired by a professional only.

**CLASS 1 LASER PRODUCT**

11. Please do use parts and accessories designated by the manufacturer.
12. Please don't put this product on an insecure cart, pedestal, tripod, support or workbench. Please be careful in using a cart, in order not to be injured for overturn of the cart or this product. 
13. When this product is used in case of thunderstorm or kept idle for a long period of time, please unplug the power cord.
14. Please have this product repaired by a professional when necessary. Once this product is damaged, for instance, its power cord or plug is damaged, liquid or foreign body enters the product, or this product is drenched with water or becomes damp or the product cannot work normally or it falls off, repair must be performed. Don't expose batteries (battery packs or assembled batteries) to sunlight, fire sources or overheated environment.

## Instructions

1. Before connecting this product to alternating current, please confirm if its rated voltage is the same as local power supply voltage. If you are unclear about the local power supply voltage, please consult with the local power supply company. The allowable input voltage ranges within AC 100V-240V~, 50/60Hz.
2. A power plug with grounding protection must be used for this electrical appliance.
3. If this product is still connected to a power socket, the alternating current power supply will not be disconnected even if the power supply has been switched off. Please unplug the plug if this product is kept idle for a long period of time. To unplug the plug, please hold the plug instead of the power cord.
4. To disconnect power supply with a power supply plug, please do make sure that the plug is easy to insert and remove.
5. Please provide favorable ventilation conditions for this product. Please don't put this product on a sofa, bed or carpet or book shelf. Please ensure availability of enough space. You'd better spare 4-inch (10cm) free space on the top, on both sides and behind.
6. High temperature might result in abnormal operation of this product. Please don't directly expose this product or its batteries to sunlight or put them near heating objects.
7. To move this product from lower temperature to higher temperature or from higher temperature or lower temperature, moisture would condense on internal laser components of this product. Under this circumstance, the product might not normally work. In this case, please turn on power supply of this product for 1 to 2 hours (without CD) so that moisture will evaporate.

## Accessories

Please check if the following accessories are contained in the package of this player:



User Manual



Power Cable



Remote Control  
With AAA batteries

## Trademark Descriptions

- DVD Logo is a trademark of DVD Format / Logo Licensing Corporation.
- The Blu-ray Disc™, Blu-ray™, Blu-ray 3D™, BD-Live™, BONUSVIEW™, Ultra HD Blu-ray™ word marks and logos and the 4K Ultra HD™ logo are trademarks of the Blu-ray Disc Association.
- Manufactured under license from Dolby Laboratories. Dolby, Dolby Vision, Dolby Audio, and the double-D symbol are trademarks of Dolby Laboratories Licensing Corporation.
- For DTS patents, see <http://patents.dts.com>. Manufactured under license from DTS Licensing Limited. DTS, DTS-HD, the Symbol, & DTS and the Symbol together are registered trademarks, and DTS-HD Master Audio is a trademark of DTS, Inc. © DTS, Inc. All Rights Reserved.
- Java and all other Java trademarks and logo are registered trademarks of Oracle and/or its affiliates.
- The terms HDMI, HDMI High-Definition Multimedia Interface, HDMI trade dress and the HDMI Logos are trademarks or registered trademarks of HDMI Licensing Administrator, Inc.



## Cinavia Notice

This product uses Cinavia™ technology to limit the use of unauthorized copies of some commercially-produced film and videos and their soundtracks. When a prohibited use of an unauthorized copy is detected, a message will be displayed and playback or copying will be interrupted.

If playback or copying is interrupted and one of the messages shown below is displayed, the content is an unauthorized copy protected by Cinavia technology.

Message	Cinavia Message Code
[Message(s) 1]	1
[Message(s) 2]	2
[Message(s) 3]	3
[Message(s) 4]	4

More information about Cinavia technology is provided at the Cinavia Online Consumer Information Center at <http://www.cinavia.com>. To request additional information about Cinavia by mail, send a postcard with your mailing address to: Cinavia Consumer information Center, P.O. Box 86851, San Diego, CA, 92138, USA.

### IPR Message











Copyright 2004-2013 Verance Corporation. Cinavia™ is a Verance Corporation trademark. Protected by U.S. Patent 7,369,677 and worldwide patents issued and pending under license from Verance Corporation. All right reserved.



**CAUTION:** This product utilizes a laser.

Do not open cover and do not repair yourself. Refer servicing to qualified personnel.

## Types of Compatible Discs

Logo	Features	Manual Icon
  	<p>BD: Compatible with 4K Blu-ray discs and Blu-ray discs containing BONUS VIEW and BD-Live content, including Blu-ray 3D discs. Displays with 3D functions and 3D goggles are necessary for 3D playing. Also compatible with single-layer and double-layer BD-R/RE discs.</p>	
	<p>DVD: Compatible with DVDs and DVD±R/RW discs issued for commercial purposes.</p>	
	<p>SACD: High-resolution stereo or multi-track audios. Notes: Some SACDs use mixed formats with CD and high-resolution DSD layer.</p>	
	<p>CD: Compatible with standard red-book CD and CD-R/RW.</p>	

## Storage and Maintenance of Compact Discs

1. Keep compact discs tidy and avoid scratching compact discs or leaving fingerprints on compact discs.
2. To take a compact disc, please hold its edge, and please don't touch its recording side.
3. Blu-ray discs record data based on polarity density, and recording layer is very close to surface of the compact disc. Hence, compared with DVD, Blu-ray discs are more sensitive to dust and fingerprints. If you encounter any problems on playing and discover any stain on a disc, please tidy the disc up using clean cloth. Please clean the disc from the center outwards along the ray. Please don't clean them by drawing circles.
4. Please don't use disc cleaning spray or solution like benzene, diluent or anti-static spray.
5. Please don't stick labels or stickers to compact discs. Otherwise, the discs will warp or be too thick. As a result, problems will occur during playing and the discs will be stuck.
6. Don't have compact discs directly exposed to sunlight or put them near heat sources.
7. Please don't use the following compact discs:
  - The compact discs with glue left by stickers or labels might be stuck inside players;
  - The compact discs which warp or crack
  - The compact discs in irregular shapes, including heart-shaped or business card-shaped compact discs.



# Product Installation Guide

## Functions of Front Panel

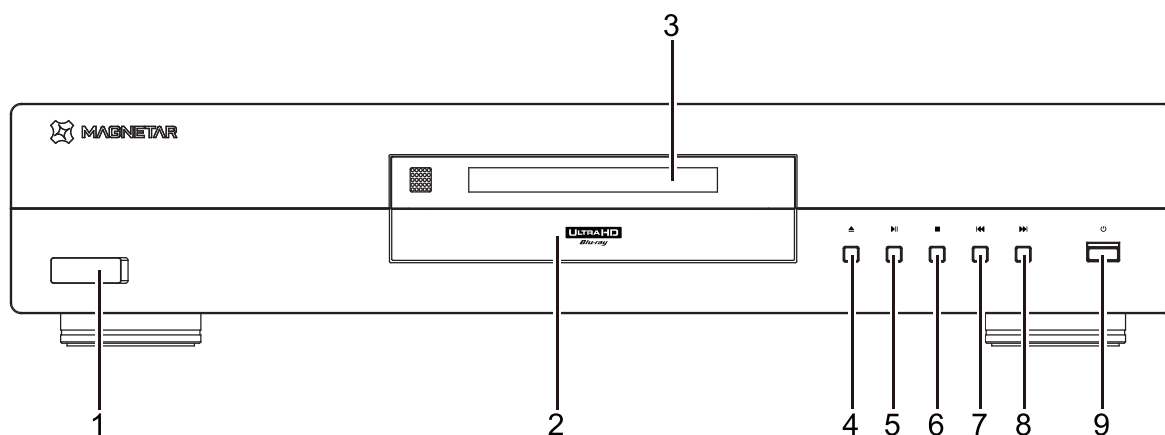

- |                   |               |              |
|-------------------|---------------|--------------|
| 1. USB Input      | 4. Open/Close | 7. Previous  |
| 2. Disc Tray      | 5. Play/Pause | 8. Next      |
| 3. Display Window | 6. Stop       | 9. Power Key |

## Display Window of Front Panel

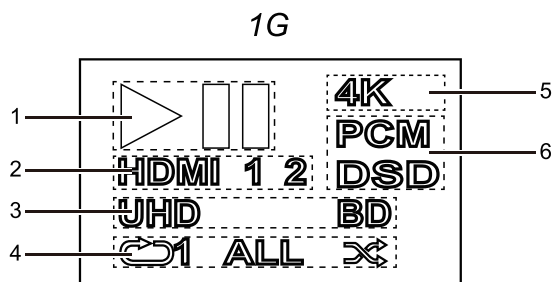
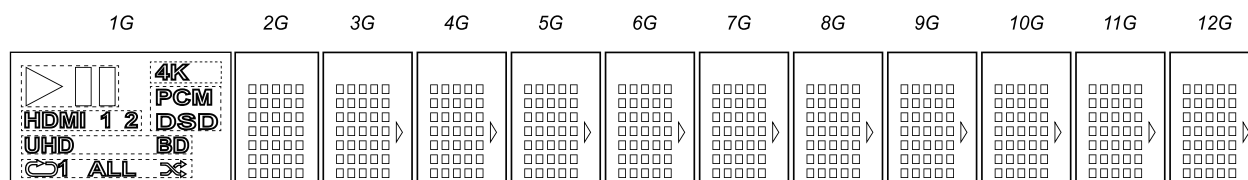

1. Playing state.
2. HDMI connection state.
3. Disc information.
4. Playing mode.
5. HDMI outputs 4K resolution
6. Digital audio output mode.
7. 2G -12G main display zone.

## Ports of Rear Panel

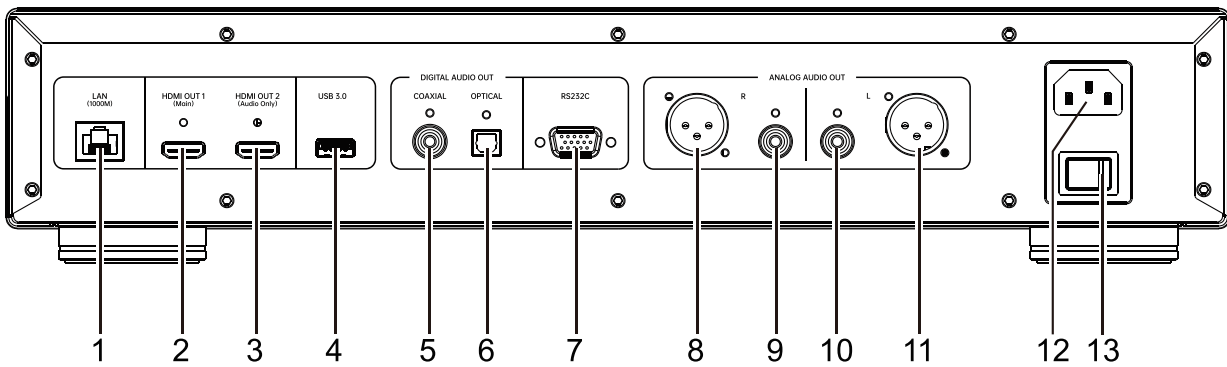

- |                           |                                    |                                 |
|---------------------------|------------------------------------|---------------------------------|
| 1. Ethernet LAN Port      | 2. HDMI Output (Main)              | 3. HDMI Output (Audio Only)     |
| 4. USB 3.0 Port           | 5. Coaxial Digital Audio Output    | 6. Optical Digital Audio Output |
| 7. RS-232C Serial Control | 8/11. Balanced Stereo Audio Output | 9/10. Stereo Audio Output       |
| 12. AC Power Inlet        | 13. Power Switch                   |                                 |

## Descriptions of Remote Control

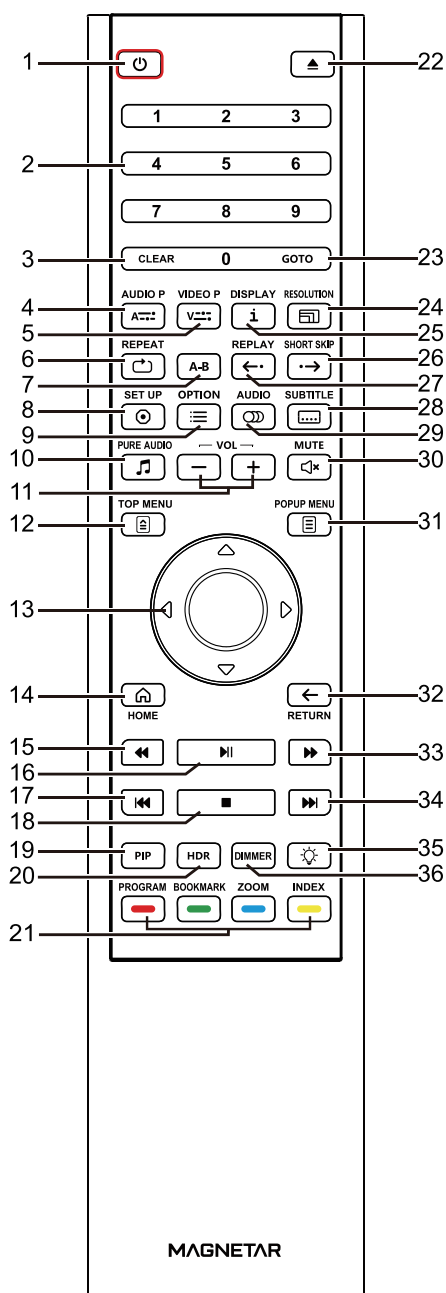

1. Power: Toggle power Standby and ON
2. Number Buttons: Enter numeric values
3. Clear: Clear numeric inputs
4. Audio adjustment: Fine tuning of audio output parameters
5. Image adjustment: Fine tuning of image output parameters
6. Repeat: Repeat playing
7. A-B repeat: Repeat playing a chosen band
8. Setup: Open the setting menu of the player
9. Option: Current option menu will pop up
10. Pure tone: Switch off HDMI video output
11. Volume +/-: Raise/lower volume
12. Disc menu: Display the menu of Blu-ray discs or title menu of DVD disks
13. Direction key: Choose the navigation menu
14. Homepage: Return to the main menu
15. Fast backward: Fast reverse play
16. Play/Pause: Start /pause playing
17. Previous: Skip to previous
18. Stop: Stop playing
19. Picture-in-picture
20. HDR: Choose the output mode for high dynamic range
21. Color key: Function varies by content
22. OPEN: Open/close the disc tray
23. Search: Jump to a certain position and start playing
24. Resolution: Switch HDMI output resolution
25. Information: Display/hide information displayed on the screen
26. Shot skip: Jump to a time point after 30s for playing
27. Replay: Jump to a time point before 10s for play.
28. Subtitle: Choose subtitle language
29. Audio: Change audio language or channel
30. Mute: Mute audio
31. Popup menu: Display popup menu of a Blu-ray disc or DVD menu
32. Return: Return to the previous menu
33. Fast-forward: Play fast forward
34. Next: Skip to the next
35. Backlight: Turn on/off backlight of the remote control key
36. Light modulation: Modulate display luminance of the front panel

### Notes

If a function is unavailable when a key is pressed, a circle with a slash will be displayed on the screen:

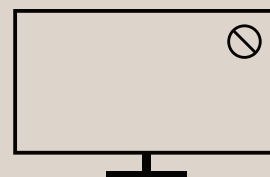

### Battery Installation

1. Open the lid
2. Put the batteries inside  
Align battery anode (+) and cathode (-) with the positions indicated inside the casing.
3. Close the lid

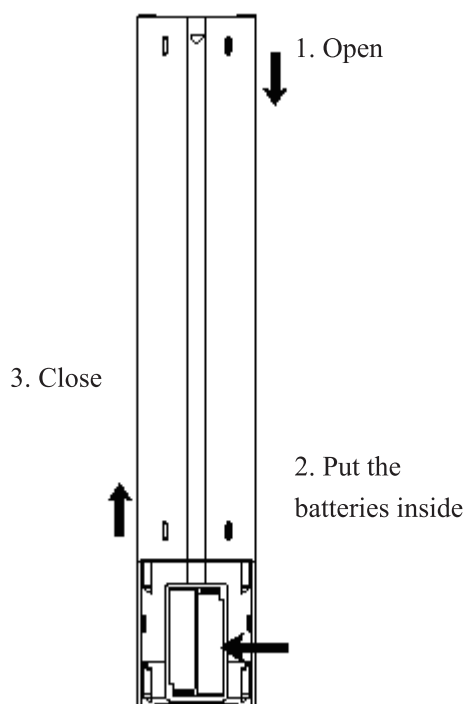

### Use of Remote Control

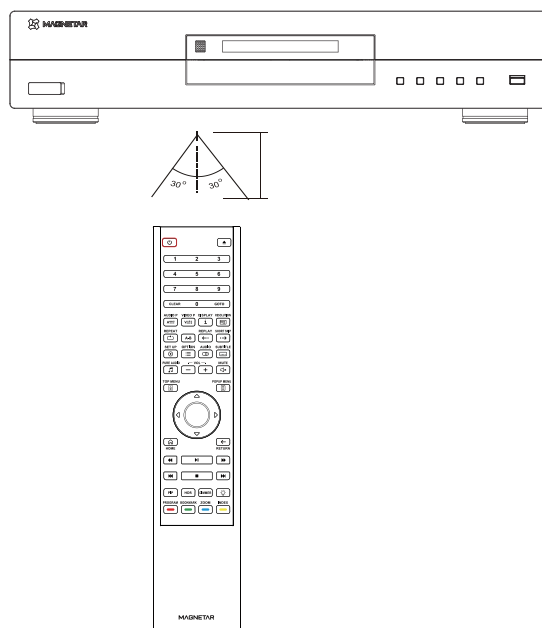

#### Caution

- Don't let the remote control fall off or put it under humid environment.
- Don't have the front remote control sensor directly exposed to sunlight or other high-intensity light sources.
- When battery is low, remote control operations would be affected. Please promptly change the batteries.
- If the remote control is kept idle for a long period of time, please take the batteries out.
- Please correctly use the batteries to avoid leakage and corrosion. Don't directly put the batteries under the sunlight or at high temperature for a long period of time.
- Don't heat the batteries or put them near flame. Don't use old and new batteries together. Don't use different types of batteries together.
- Don't charge batteries.
- In case of battery leakage, don't directly touch the liquid by hand. Please fully clear liquid out of the battery chamber, and mount new batteries.

# Common Connections

## Connecting to an A/V Receiver via HDMI

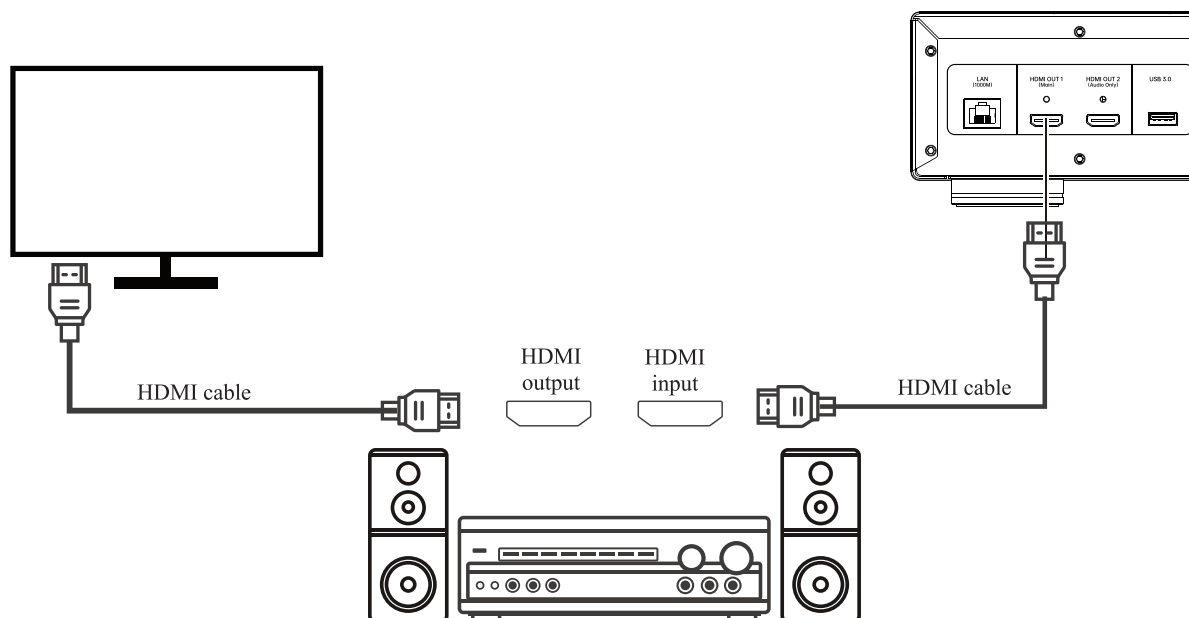

- If your Receiver has HDMI functions and supports 4K HDR video transmission, you will only have to connect the HDMI OUT (Main) port of the player to the power amplifier using an HDMI cable, and start HDMI video transmission on the power amplifier (for more information, refer to the user manual for receivers). Generally, the power amplifier is equipped with HDMI output, and can be connected to a display device to transmit video signals.
- Some power amplifiers have both HDMI 2.0 and HDMI 1.4 ports. To normally watch 4K contents, please connect this product to 4K UHD TV input ports which are compatible with HDMI 2.0 and HDCP 2.2.

### Notes

- HDMI (high-definition multimedia interface) can simultaneously transmit audios and videos from the player to a display device. However, please beware that HDMI standards are still in the stage of constant improvement, so they might still have problems in terms of compatibility. The power amplifier must be compatible with HDMI audio inputs. Certain power amplifiers only provide HDMI for video switching. If the power amplifier has no function for audio input, please refer to other related connection methods described below.
- For Blu-ray discs, it is better to use power amplifiers with Dolby TrueHD and DTS-HD Master Audio decoding functions which are compatible with HDMI v1.4.
- For 4K Blu-ray discs, please use power amplifiers compatible with HDMI 2.0 and HDCP 2.2 or higher versions. It is recommended that superior high-speed (18Gbps) HDMI cable should be used for guaranteeing watching of 4K UHD videos.
- The formats supported by this product range from the latest object-oriented surround sound from source codes to decoding formats, including Dolby Atmos and DTS:X.
- Please check specifications of your power amplifiers to make sure of satisfying these needs.

## Connecting to a TV via HDMI

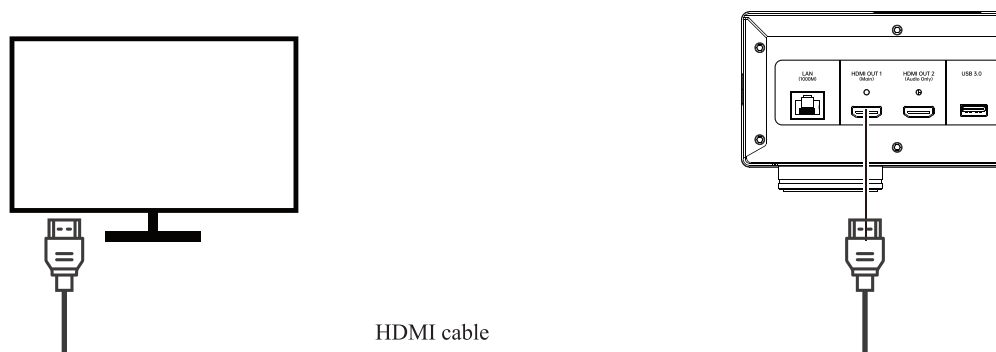

- Connect HDMI OUT (Main) port of the player to a TV set using an HDMI cable. For this connection, pure digital video and audio signals are simultaneously transmitted using a cable.
- For normally playing 4K UHD contents, please do connect the HDMI OUT (Main) port of the player to a 4K UHD TV set compatible with HDMI 2.0 and HDCP2.2.

### Notes

- For this connection, sound is output through the speaker of the TV set. For the best sound quality, you'd better transmit audio from this product to an A/V power amplifier with speaker.
- Please use a 4K TV set compatible with HDMI 2.0 and HDCP 2.2, to make sure that 4K Blu-ray discs and other 4K content can be normally watched with 4K resolution.
- Please use an HDR (high dynamic range images) TV set for watching HDR content.
- Please use a high-speed (18Gbps) HDMI cable for connection, to make sure that 4K 60Hz videos can be watched.
- Please don't output HDMI OUT (Audio Only) to the TV set.

## Connecting to a TV and an A/V Receiver via Dual HDMI

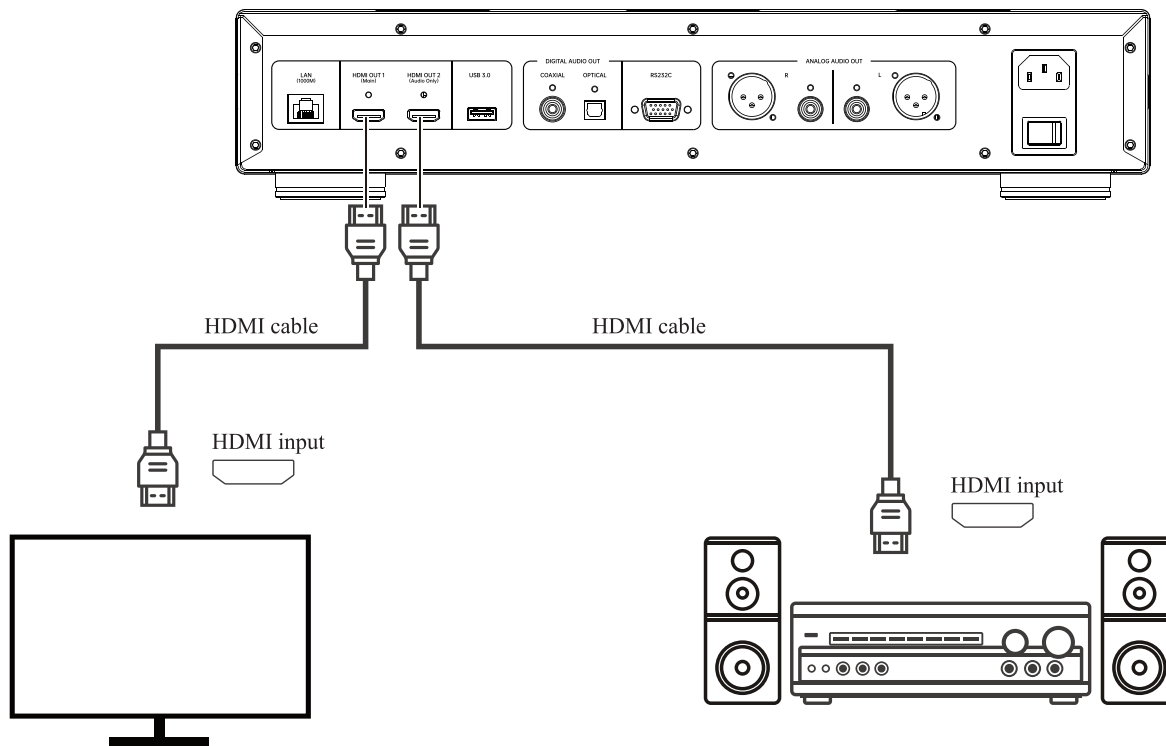

- “Dual HDMI connection” of this product does not only guarantee audios with high bit rate, but also assures the highest video quality and resolution. You can connect the HDMI OUT (Main) port to a TV set using an HDMI cable, and connect the HDMI OUT (Audio Only) port to the power amplifier with another HDMI cable.
- If your display device has 3D or 4K image functions, but your power amplifier does not have these functions, this configuration method will be recommended. Then, video signals (3D or 4K images) can be directly sent to the TV set, and audio signals will be sent to the power amplifier.

### Notes

- Please refer to instructions on HDMI connection.
- If your receiver doesn't support HDMI audio input, please try other connections.

## Connecting to a Stereo System via RCA

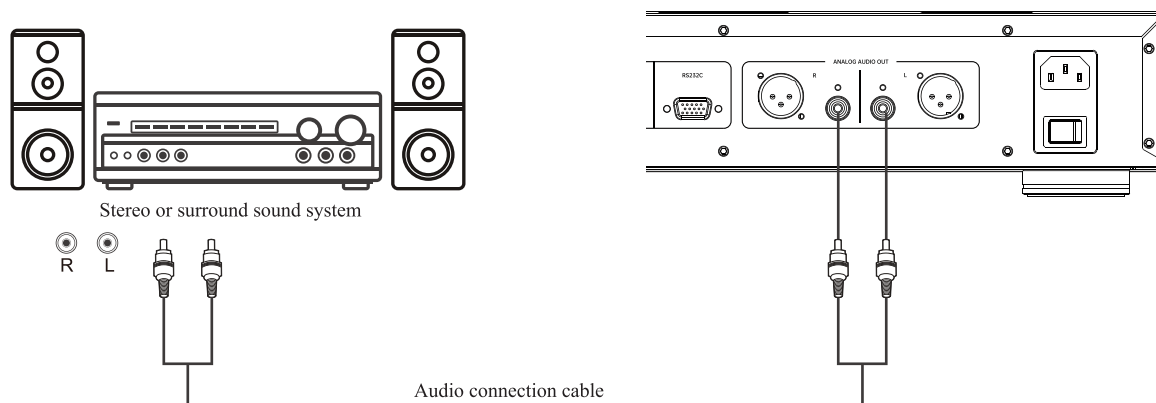

- If your sound system only has a stereo input port or you want to connect your surround sound system to an independent stereo system in addition to HDMI, optical fiber or coaxial output port, you can connect that system to the independent STEREO AUDIO OUT port of this player.
- This product has two groups of stereo audio output ports: RCA terminal and XLR balanced terminal.
- You'd better give priority to choose XLR terminal, because it outperforms the RCA terminal in noise suppression and signal integrity.

### Notes

- Independent stereo output ports will automatically down mix multi-track audio source signals into stereo signals, but independent stereo output will not be affected by down mix or menu setting>other speaker setting options of sound processing.



## Connecting to a Stereo System Using an XLR Balanced Audio Cable

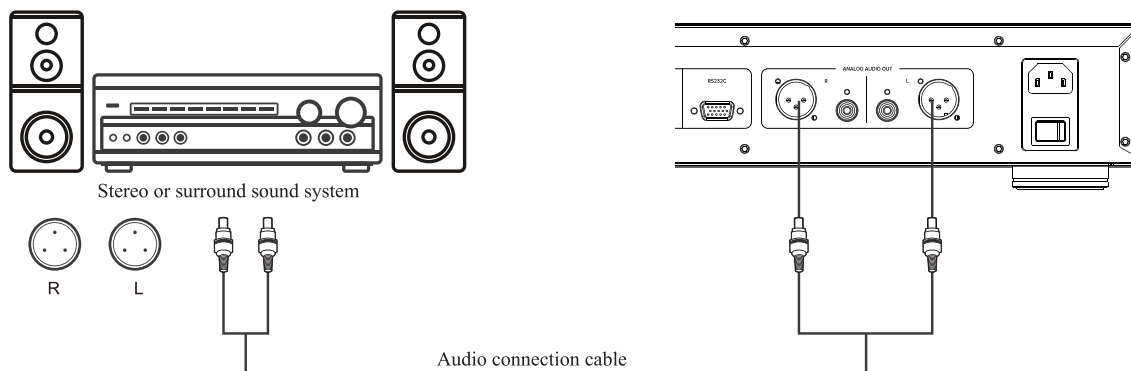

- You can also connect the XLR BALANCED STEREO AUDIO OUT to the stereo system. Please use XLR3 balanced audio cable, and the XLR port of this player is a male terminal.

### Notes

- The XLR BALANCED STEREO AUDIO OUT is commonly used for specialized electronic audio devices, including high-quality microphones and cables connected between devices.
- This product uses XLR port (as shown in the figure below) and transmits a pair of differential signals (positive/negative signals). Back-end circuits can cancel common-mode noises and increase integrity of original signals by comparing voltage differences between this pair of signals.

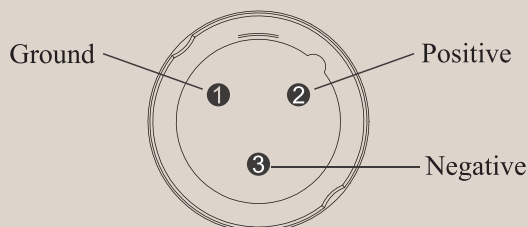

This product uses male XLR terminal

## Connecting to an Amplifier through S/PDIF (Optical/Coaxial)

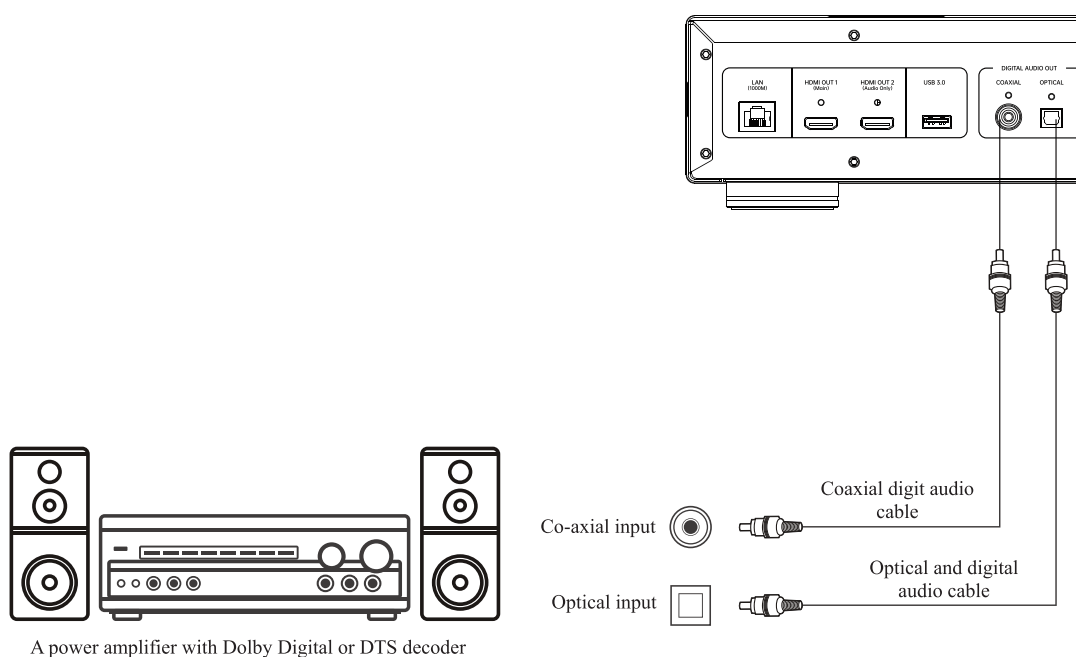

- Please connect the optical or coaxial audio output to corresponding output terminal of the A/V power amplifier using a 75  $\Omega$  coaxial digital audio cable or S/PDIF optical/digital audio cable with RCA plug.

### Notes

- Owing to bandwidth limits, high resolution audios in formats such as Dolby Digital Plus, Dolby TrueHD, DTS-HD High Resolution and DTS-HD Master Audio cannot be output in a coaxial manner or through optical fiber cable. The aforementioned sound tracks will be replaced by versions with lower resolution. Please use HDMI for connection of your power amplifier can process HDMI audio inputs, in order that high resolution audios can be in the best format. Otherwise, use multi-track analog output.
- Due to copyright limitations, SACD audios cannot be transmitted through coaxial or optical/digital audio output. To appreciate SACD, please choose HDMI or analog audio connection.
- Because of copyright and bandwidth limitations, high resolution audios of DVD-Audio discs cannot be transmitted through co-axial or optical and digital audio outputs. To appreciate high resolution DVD-Audio discs, please choose HDMI or analog audio connections.

## Connecting to the Internet

This product can also play audios, videos and photos through a home network. This option supports NFS, DLNA and SAMBA/CIFS. This product also supports BD-Live available from certain Blu-ray discs. BD-Live provides extra downloadable content and additional online interactive programs. BD-Live content varies with discs and publishers. They might include extra captions, comments, movie trailers, games and online chat. To use BD-Live through the Internet, this player has to be connected to the broadband Internet. If you needn't use online streaming media, it will be unnecessary to connect BD-Live to the Internet.

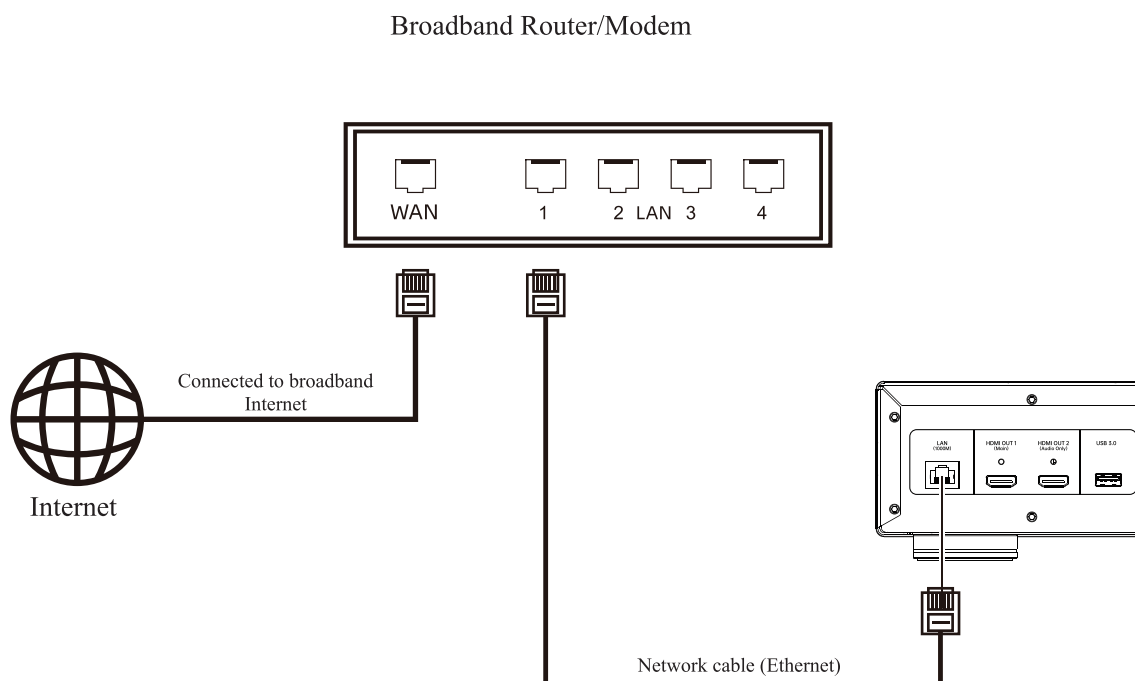

- Insert one end of the network cable (type 5/5E straight Ethernet cable) into the LAN port on the back panel of this product.
- Insert the other end of the network cable into the LAN port of the broadband router or modem.
- After this player is connected to the broadband Internet, some network configurations might be needed.
- For setting the broadband router or modem, please refer to related instructions or contact the Internet operator.

### Notes

- Only the LAN ports of this player can be connected to Ethernet ports compatible with 1000BASE-T, 100BASE-TX or 10BASE-T. Its connection to other ports or interfaces such as phone interfaces will cause damages to the player.

## BD-Live



Titles of certain Blu-ray discs have functions of BD-Live (Blu-ray interactions). BD-Live provides extra downloadable content and additional online interactive programs. The BD-Live content also varies with discs and publishers. They might include extra captions, comments, movie trailers, games and online chat. Only if the

player is connected to the broadband Internet can it play BD-Live content.

BD-Live content is represented in different forms dependent upon manufacturers' organization of the content. For instance, start downloading BD-Live content at the start time of playing, and BD-Live will be optional on the main menu of the disc. Reminders will be displayed to ask you if you need to start downloading, and inquire you if you have to register membership or an account. Please enjoy the BD-Live content based on disc instructions.

Your Internet connection speed and capacity of BD-Live content server will affect download speed of the BD-Live content. If you find that download is slow or playing is intermittent, you'd better only play contents of the disc without using the BD-Live function, or try again at some other time. When you use the BD-Live function, your player ID, compact disc and IP (Internet protocol) address would be sent to the content provider through the Internet. Generally, no information on personal identity will be sent. Instead, there are really certain technologies which will match your IP address with certain geographical areas or service providers. Therefore, your Internet service provider is able to know who is using a certain IP address. If the BD-Live content provider requires you to log in with membership qualification or an account, it will be able to obtain information about your membership qualification or account. Please confirm with your Internet service provider and BD-Live content provider about their privacy policies.

You can restrict the access to the BD-Live network by setting menu of the player.

# Basic Operations

## Disc Playback

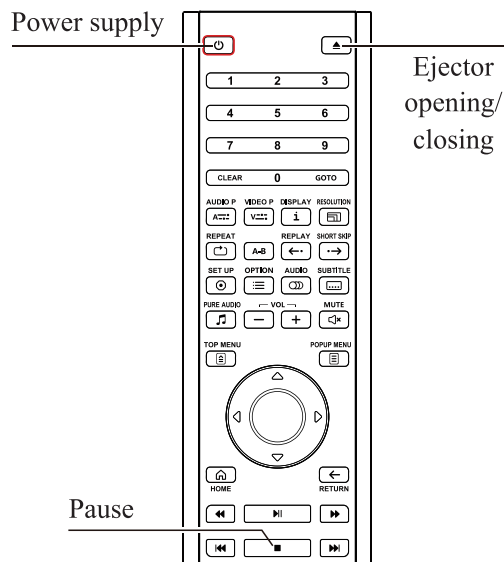

1. Power on the player by pressing the **power key**.
2. Press the **ejector opening/closing key**. Then, the disc Ejector will pop out.
3. Put the printed side of a disc upward and the recording side downward.

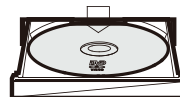

4. Press the ejector **opening/closing key** to put the disc away.
5. The player will read the disc information and start playing.
6. The menu or navigation interface might be displayed dependent upon disc content. Please choose the content to be played by pressing the **direction key and OK**.
7. To stop playing, press the **stop key**.
8. To switch off the player, press the **power key**.

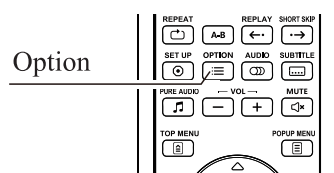

1. Press the **OPTION** on the remote control and open the option menu during navigation and playing of a media document.
2. When the option menu is displayed, press the **up/down key** on the remote control to highlight specific options. Then, press the **OK key** for confirmation.

## Option Menu

For different types of content, options would vary. The options and corresponding functions are summarized as follows:

### In playing video discs (DVD, BD) and video documents:

- Caption setting: Choose requisite caption languages among captions available.
- Track setting: Choose requisite sound tracks among those available.
- Replay: Repeated sections, headings or the whole disc.
- Image adjustment: Display a menu for image adjustment.

### In playing audio discs (CD, SACD) and music documents:

- Programmed playing: Play songs based on the set order of precedence (only available in playing CD).
- Replay: Replay the current song or all songs.
- Disorderly and random playing: Turn on disorderly and random modes.

### In playing image documents:

- Disorderly and random playing: Turn on/off disorderly and random playing modes;
- Switching method: Change the method for playing slides.

## Fast Forward and Reverse

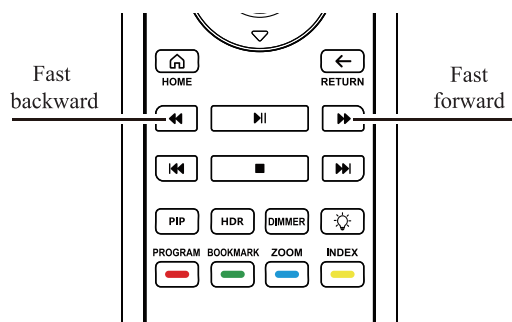

You can perform fast forward or fast backward operations at the time of playing.

1. Press the **fast forward key** on the remote control. Then, the player will start playing fast forward. Whenever the **fast forward key** is pressed, the player will adjust the play speed in order as follows:

▶ →▶▶▶ 2x →▶▶▶▶ 4x →▶▶▶▶▶ 8x →▶▶▶▶▶▶▶ 16x →▶▶▶▶▶▶▶▶▶▶ 32x

2. Press the **fast backward key** on the remote control. Then, the player will start playing fast backward. Whenever the **fast backward key** is pressed, the player will adjust the play speed in order as follows:

▶ →◀◀◀◀ 2x →◀◀◀◀◀◀ 4x →◀◀◀◀◀◀◀◀ 8x →◀◀◀◀◀◀◀◀◀◀◀◀ 16x →◀◀◀◀◀◀◀◀◀◀◀◀◀◀◀◀◀◀ 32x

### Notes

- Certain Blu-ray discs using BD-Java might have their own fast forward and fast backward control. Actual speed might somewhat differ among the discs, and progress is even displayed for certain discs.

## Slow Playback

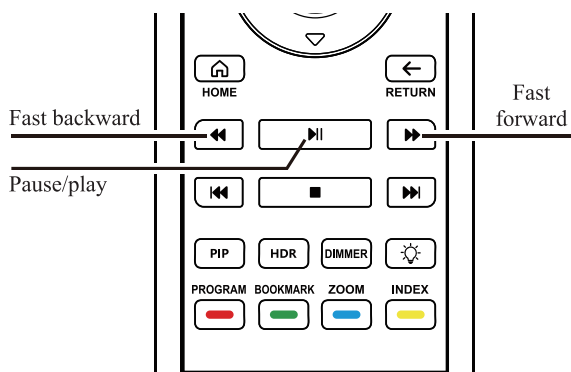

To play a video slowly, please follow the following steps.

1. First, press the **pause key** on the remote control to stop playing.
2. Press the **fast forward key** to choose a low forward playing speed. Whenever the **fast forward key** is pressed, the playing speed will change in order as follows.



3. Press the **fast backward key** to choose a low playback speed. Whenever the **fast backward key** is pressed, the playing speed will change in order as follows.



4. Press the **playing key** to exit from the slow playing mode.

## Pause and Frame-by-frame Playing

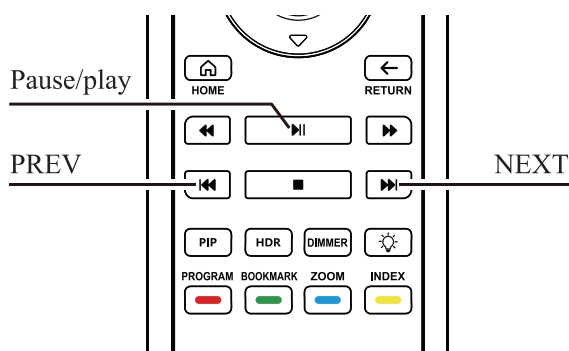

1. The playing may be suspended by pressing the **pause/playing key** during playing. Under this mode, a pause icon will show up on the TV screen.
2. When a DVD or a Blu-ray disc is under the paused state, press the **PREV** or the **NEXT**, so that video images will be played forward or backward frame by frame.

## Blu-ray Disc Menu

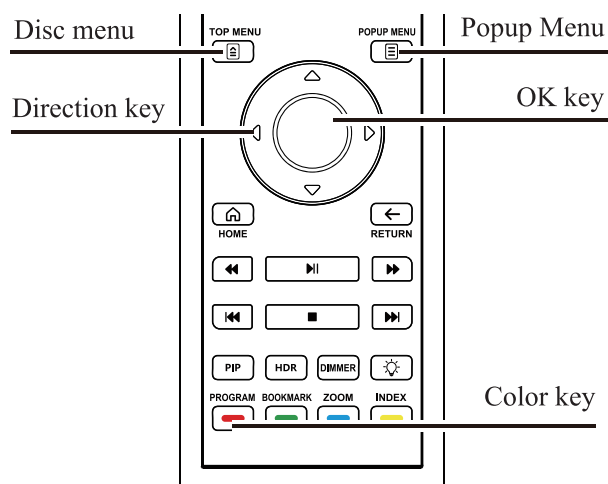

1. A Blu-ray disc menu usually comprises of a disc menu and a popup menu. The disc menu usually appears behind preview and copyright information after the player starts playing. The popup menu may appear in the process of playing a movie, which needn't be suspended.
2. In the playing process, press the **disc menu key** to enter the disc menu, and press the **popup menu key** to enter the popup menu.
3. Browse the menus by the **direction key**. Then, press **OK** to confirm your choice.
4. Color keys are used in some menus. You can press corresponding **color key** on the remote control to choose menu functions.

## Audio Control

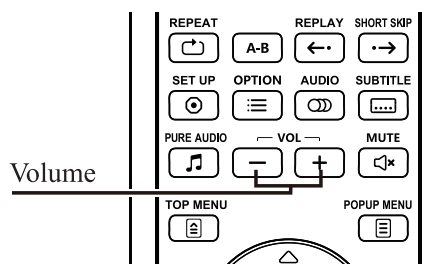

1. Audios can be controlled with the **VOL +/-** on the remote control. You'd better set audios of the player to be the same as other information sources (e.g. TV programs or VCR).  
Press **VOL +** to increase radio volume.  
Press **VOL -** to lower audio volume.

## Mute

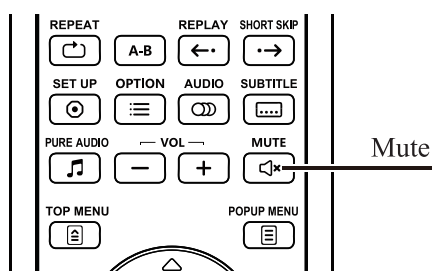

1. By pressing **MUTE** on the remote control during playing, the audio output will be turned off, and a mute icon will be displayed on TV screen.
2. Press **MUTE** again to recover the audio output.

## Track Selection

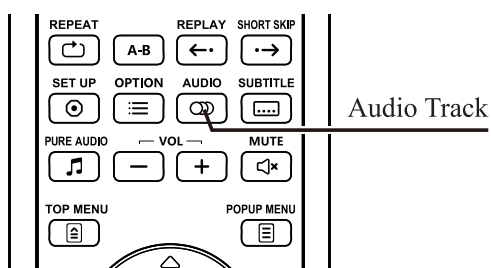

1. Press the **track key** on the remote control during playing and choose track.
2. Repeat pressing the **track key** or the **up/down key** to choose the track available.

### Notes

- The tracks available vary among discs. For certain DVD-Audio discs, tracks can be selected through the track key. For other discs, track choices have to be made by users in the sound setting menu. For multi-track and stereo playing of SACD, the track key can be pressed between the two modes.

## Subtitle Selection

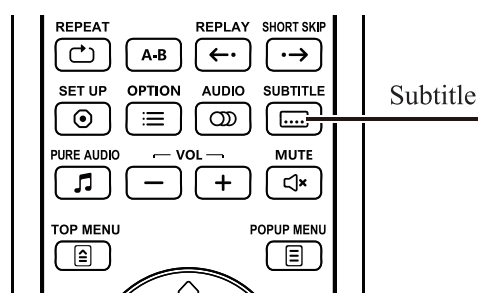

1. In playing DVD, Blu-ray discs or other video programs with captions, press the **subtitle key** on the remote control to choose requisite captions.
2. Repeat pressing the **subtitle key** or **up/down key** to choose the subtitles available.



# Advanced Operations

## Repeated Playback

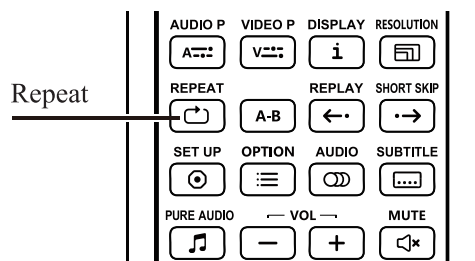

1. To repeat a disc, song, heading or section, press **repeat** on the remote control.
2. Whenever **repeat** is pressed, the repeat mode will be switched in order.

## Repeat Choosing a Segment

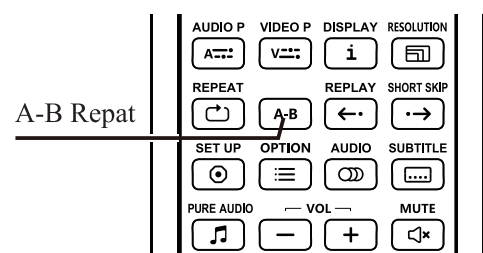

To repeat playing a certain segment, please follow the following steps:

1. In the course of normal playing, press **AB** on the remote control at the desired start point to set repeated playing. Then, “A-” will be displayed on the TV screen.
2. When playing at the desired stop point (Point B), press **AB** again. Then, the player will repeatedly play the designated part (A-B), and “A-B” will be displayed on the TV screen.
3. Press **AB** for the third time, and normal play will be recovered.

### Notes

- Some disc formats or content might be inapplicable. Repeated playing might be disallowed for certain Blu-ray discs.

## Pure Audio Mode

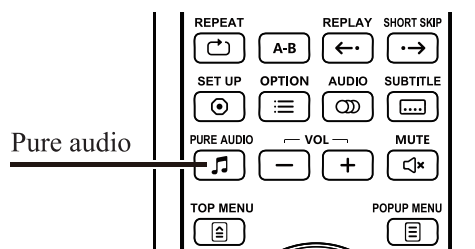

Under the pure audio mode, any potential interference between video and audio signals is reduced by turning off video processing and output.

1. Press **pure audio** on the remote control, and “pure on” will be displayed on the display screen. At this moment, the player will enter the pure audio mode, and video output will be turned off accordingly.
2. Press **pure audio** again, and “pure off” will be show up on the display screen. At this time, recover normal video output and cancel the pure audio mode.

### Notes

- HDMI simultaneously transmits audios and videos, so HDMI video signals cannot be fully turned off. Instead, black screen will appear, and potential interference can be maximized.

## Zooming and Display Ratio

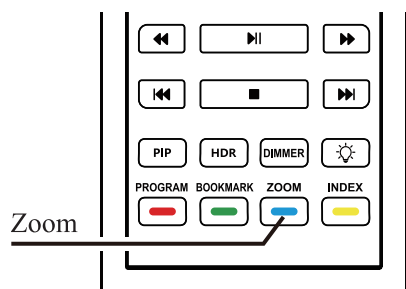

This function is used for amplifying or narrowing display frames.

Press **zoom** on the remote control to change the zoom level.

Whenever **zoom** is pressed, switch the zoom level in order.

The following zoom levels are optional:

1:1 (no zoom), 2X, 3X, 4X, 1/2X, 1/3X, 1/4X

## Memory and Automatic Resume

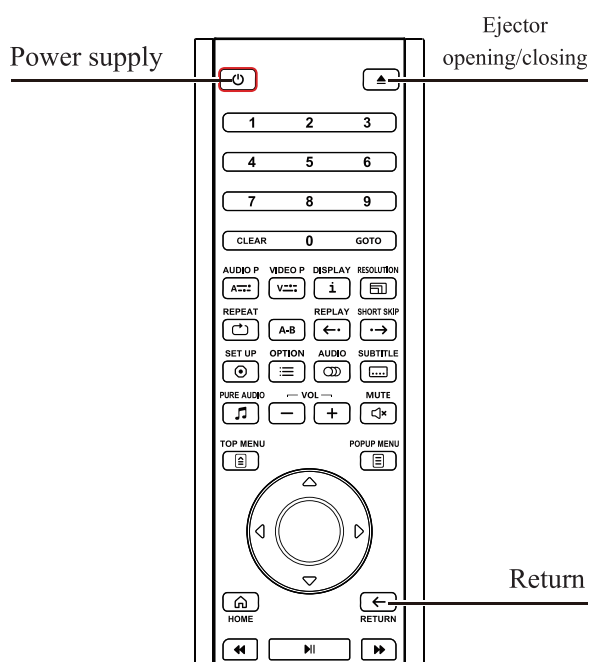

1. When playing is suspended, the player will automatically memorize the current position. In opening the Ejector or turning the player off, the player will save where it is playing.
2. Even if the device is powered off or the disc is replaced, the memory on where the player is playing will remain.
3. To play a disc with such memory, the player will identify where the disc has been played as saved, and automatically continue playing from the memorized part. If you want to cancel automatic playing continuance, the player will replay from the beginning. You can press **RETURN** when any reminder is displayed.
4. This player can memorize where 10 discs have played at most. To memorize the 11<sup>th</sup> disc, the earliest memory will be replaced.

### Notes

- Certain Blu-ray discs don't have functions for playing based on memories. They can only play discs from the beginning.

## Playback by Track Number

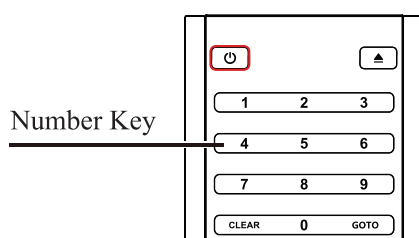

In playing a disc, you can directly jump to certain song by pressing the **number** on the remote control. For instance:

- To choose the 7<sup>th</sup> song, please press [7].
- To choose the 16<sup>th</sup> song, rapidly and continuously press [1] and [2].

### Notes

- For certain DVD-Audio and Blu-ray discs, the sections to be played might not be directly chosen.

# Media File Playback

This product can also play digital media documents apart from standard disc formats such as Blu-ray discs, DVD, CD and SACD. You can appreciate data discs (recordable CD, DVD or Blu-ray discs), USB flash disks, hard disks or network storage devices.

Owing to diversity of media documents, coding software and technologies, we cannot assure compatibility with all your original or downloaded content, but we will try our best to provide support in respect of such content.

## Playback from USB Storage Devices

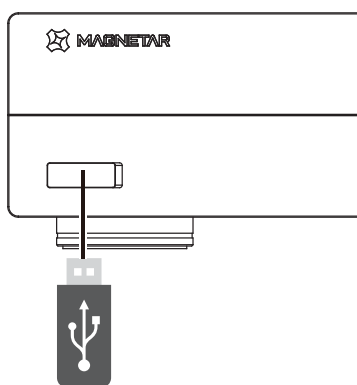

(USB 2.0)

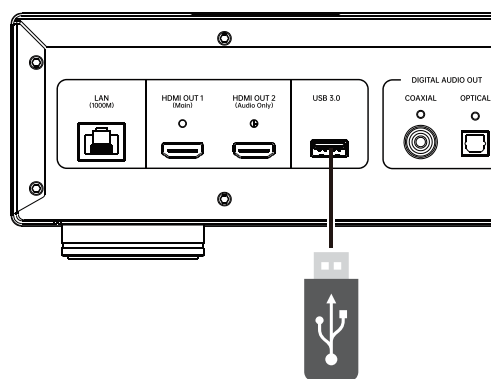

(USB 3.0)

This product has two USB ports: including one USB 3.0 port on the back panel and one USB 2.0 port on the front panel. You can connect a USB storage device to either of these USB ports.

The USB ports are used for supplying maximum power supply (5 V, 500 mA) for USB storage devices. This power supply is high enough for all USB flash disks and flash memory card readers, but might be insufficient for USB portable hard drive.

Therefore, in using USB portable hard drive, you'd better use external power supply. The USB port on the front panel is only used for upgrading, and must not be utilized for supplying power to other equipment.

### Notes

- This function is for USB storage devices only. This type of equipment is compatible with a majority of USB flash disks, mobile hard disks and card readers. For other devices (including MP3 players, digital cameras and cellphones), there might be compatibility problems.
- All compatible USB storage devices must be in FAT, FAT32, exFAT formats and compatible with NTFS.
- Incompatible USB storage devices might make the player stop responding. Under this circumstance, it is only necessary to switch off power supply and remove the USB storage device before turning on the player again.
- The player reads the USB storage devices under the read-only mode. To minimize risks of data damages, you'd better not remove the USB devices until the player stops playing.

## Main Menu

This product provides a main menu to help you browse and play discs/USB flash disks and sharing local area networks. The main menu is the starting point for accessing media documents.

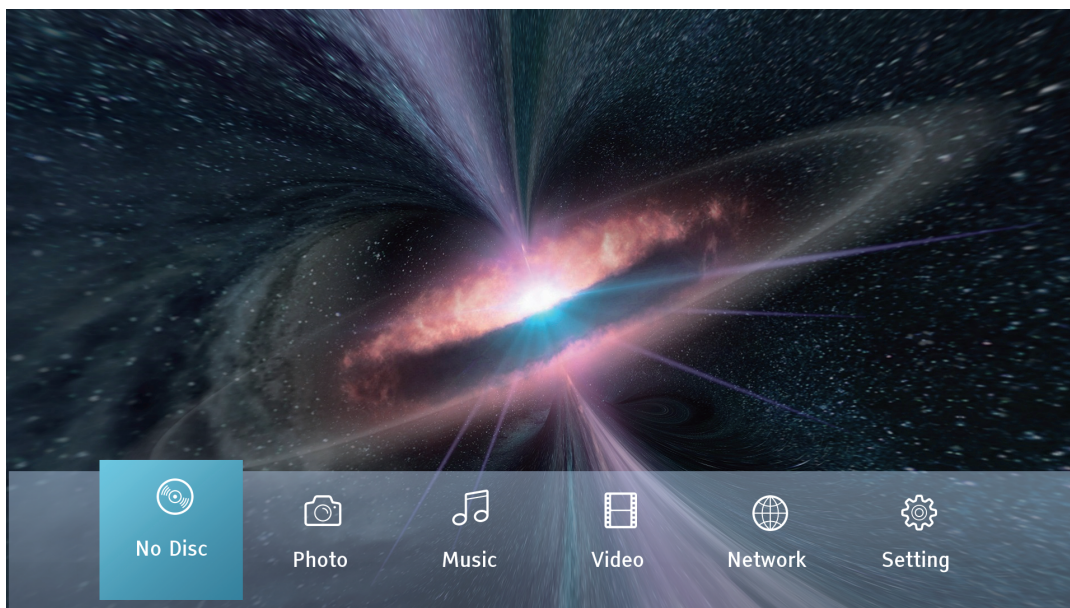

**You can call up the main menu from the MAIN MENU on the remote control. At present, there are 6 options:**

- Choose a compact disc. Then, the player will start playing the inserted disc.
- With pictures, music and videos, you will be allowed to access corresponding types of media documents from connected storage devices and inserted data discs.
- The network can enable the player to play audios, videos and pictures of home media servers by streaming media. Hardware and software with corresponding functions might be needed.
- Set the settings menu from which the player may be called up.

## Play Music Files

To play music documents of compact disks or USB storage devices, please choose the music option in the main menu. Then, the document browser will be opened to help you browse documents and files. First, choose a data disc or storage device containing music documents. It will take the player some time to read media information and list files and music documents.

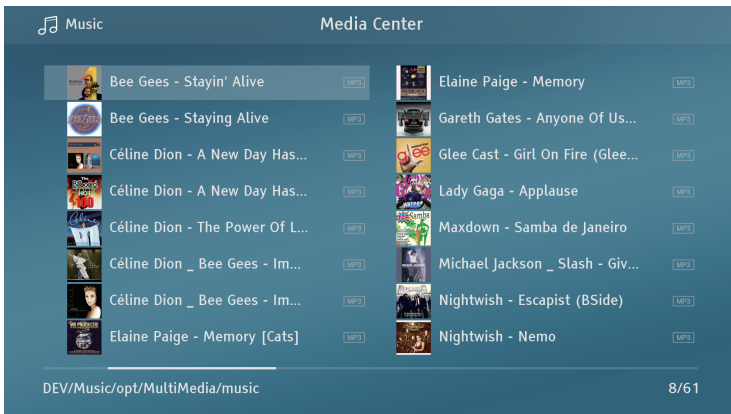

**In a music browser, the following operations can be performed:**

- Choose a music document by pressing the **up/down/left/right key** to move the cursor.
- Press **OK** for playing.

**The following information will be displayed on the playing interface:**

- Display playing status: play, pause, song and time.
- Display and modify playing modes: disorderly playing, random playing, single song on repeat and repeat all.
- Music information.

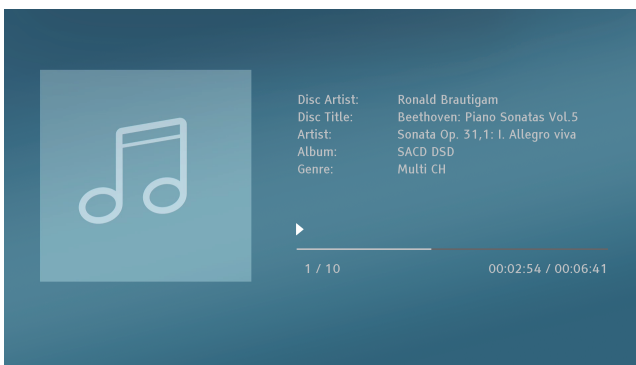

The following operations can be performed on the playing interface:

- Routine playing control: **Play, stop, pause, PREV/NEXT, fast backward and fast forward.**
- Return to the previous menu without stopping music playing: Press the **return key**. Stop playing and return to the browser: Press the **stop key**.

## Play Movie Files

To play video documents of a compact disc or a USB storage device, please choose the video option in the main menu.

Then, the document browser will be opened to help you browse documents and files.

First of all, choose a data disc or a USB device containing video documents. It will take the player some time to read media information, and list files and video documents.



The following operations can be performed in the video browser:

- Press the **up/down/left/right key** to move the cursor to choose video documents.
- When a video document is chosen, press **OK** to start playing.

**Once the video document is played, the following functions can be used for playing control:**

- By pressing the **stop key**, the player will stop playing the video and return to the document browser.
- Press the option key for choosing captions and audios, etc.

## Viewing Photo Files

To play image documents of a compact disc or a USB storage device, please choose the image option in the main menu.

Then, the document browser will be opened to help you browse documents and files.

First, choose a data disc or USB device containing image documents. It will take the player some time to access media information, and list files and image documents.



**In the image browser, you can perform the following operations:**

- To choose video documents, press the **up/down/left/right key** or **page up/down key** to move the cursor.
- When an image document is chosen, press **OK** or the **playing key**. Then, the player will start playing under the full-screen slide show mode.

The following operations can be performed in the process of image playing  
Routine playing control: **Play, stop, pause, PREV/NEXT.**

Repeated browsing: **Repeat.**

Random playing: **Yellow key.**

Image zooming: **Yellow key.**

Turn left (counterclockwise): **Leftward key.**

Turn right (clockwise): **Rightward key.**

## Add Background Music

You can also add background music for browsing image slides. For this operation, you have to prepare some digital music documents.

First, choose music in the main menu and start playing music. Then, press the return key to return to the main menu. Choose images. Then, start browsing and playing slides in routine ways.



## Playback from a Home Network

This product can remotely play music, pictures and video documents stored in media devices connected to the same home network with it. You have to prepare a set of hardware like a computer (network attached storage) server connected to the same network segment as the player. Install and configure software which is functionally equivalent to NFS, DLNA or SAMBA/CIFS (a protocol for sharing network documents) client. In the setting menu, my network setting is enabled. Choose the network icon in the main menu. Then, press OK, and a list of servers available will be displayed. In some cases, you might have to disable the hardware firewall, to allow access to the server by this product.



For the UDP800 player, a network can be shared in any of the following three ways

- **Function as digital media player (DMP):**  
The player can actively search the local DLNA server, browser and play the share content therein.
- **Access SMB/CIFS:**  
The player can actively search the SMB/CIFS, brows and share the content therein with the player.  
For instance, the documents shared in the neighborhood document of Windows.
- **Access NFS:**  
The player can actively search the NFS, and browse the content it shares with the player.  
Generally, it will take more time to search the NFS.

# Setup Menu Options

The setting menu of this product provides various setting and configuration options. For a majority of users, default configurations have been perfect enough, so no setting needs to be modified. To be sure, if you want to adjust configurations of the player so that they will perfectly match settings of your home cinema and your movie watching habits, please read the following contact, to understand details of configuration options.

## Use the Setup Menu

You can use the setting menu for adjusting settings of this player, in order that they will be fit for specific audio/video configurations. In making these adjustments with the menu, we will indicate positions of requisite functions as follows:

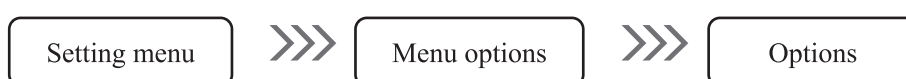

Setting categories belong to the first level of the setting menu. This product has 7 setting categories altogether, which are on the left column of the setting menu, including **display, audios, playing, network, safety, language and options.**

The menu options contain adjustable parameters, which are in the center of the setting menu. In entering a setting category, the list of menu options under that category and corresponding current settings will be displayed in the box.

The options are exact numerical values or descriptive phrases, which represent variations in chosen factors and are on the right of corresponding menu options.

When so many options are available on an interface that they cannot be fully displayed, you can check more options by pressing the **up/down key**.

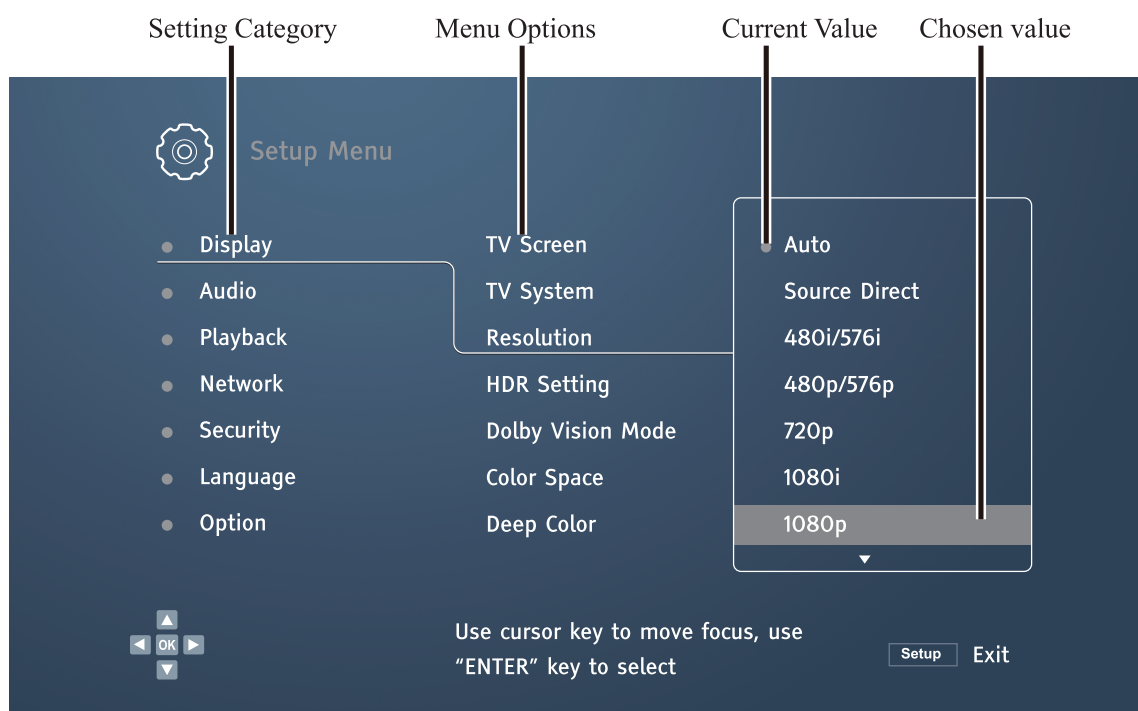

## Display Setup

For display setting in the setting men, you are allowed to configure video output options.

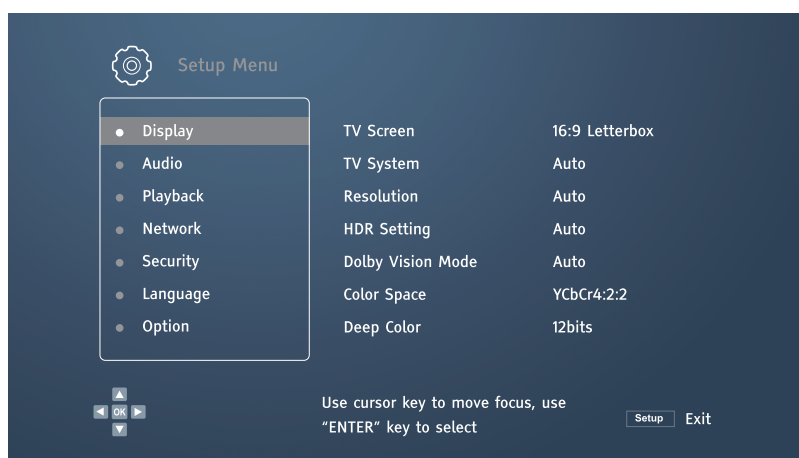

### TV Screen

**TV aspect ratio:** The player adjusts output aspect ratio according to aspect ratio of current display equipment, in order that videos viewed by users will not deform.

**Full screen** --- The videos output by the player are always displayed on a full screen.

**Letterbox** --- When TV aspect ratio differs from the video aspect ratio, choose this option. There will be black blocks on the upper or lower, left or right part of the TV screen.

**Pan & Scan** --- When TV aspect ratio differs from the video aspect ratio, choose this option. The video contents on the upper or lower, left or right part will be cut.

### TV System

Choose HDMI video signal output system

**Auto (default)** --- The player automatically chooses a video signal output system based on the source content.

**NTSC** --- Compulsorily output NTSC video signals.

**PAL** --- Compulsorily output PAL video signals.

### Resolution

**Output resolution:** Choose the output resolution of the original resolution which best matches TV

Auto                      720P                      4K2K 24hz

Source Direct            1080i

480i/576i                1080p

480p/576p                4K2K

### Notes

- If a TV set is not compatible with the chosen resolution, black screen or wrong information will be displayed. Under this circumstance, please press the resolution key on the remote control for 3 to 5 seconds before switching to the resolution suitable for the TV set.

## HDR Setting

Choose a suitable mode for HDR images

- Auto (default)** --- When both source contents and display equipment support HDR, there will be HDR output. The player will automatically detect if HDR source content and TV set or projector are compatible with HDR. If both conditions are satisfied, the player will output HDR videos via the HDMI OUT (Main) port. Otherwise, SDR videos will be output only.
- HDR** --- Enable the HDR function.
- SDR** --- HDR source contents will be converted into SDR.

## Dolby Vision Mode

Choose HDMI Dolby Vision output mode.

- Auto (default)** --- When both source contents and display equipment support Dolby Vision, the player will automatically choose the optimal output mode.
- Low Latency** --- When the source contents are Dolby Vision and the display equipment supports the (low-latency) Dolby Vision mode, choose this option, and the player will output the (low-latency) Dolby Vision mode.
- LL RGB** --- Low Latency with RGB color space.
- Off** --- Ban outputting Dolby video signals.

## Color Space

Choose color space for HDMI output.

- RGB Video Level** --- Use RGB color space within a confined scope of [16-235] for HDMI outputs.
- Full RGB** --- Use RGB color space within the full range of [0-255] for HDMI outputs.
- YCbCr4:4:4** --- Use YCbCr4:4:4 color space for HDMI outputs.
- YCbCr4:2:2(default)** --- Use YCbCr4:2:2 color space for HDMI outputs.

## Deep Color

Choose color depth for HDMI outputs. Increase color depth so that color transition will be smoother and color gradation will be more desirable.

- 10 bits** --- Players automatically select a color space of no more than 10 bits based on the support list of the display device.
- 12 bits** --- Players automatically select a color space of no more than 12 bits based on the support list of the display device.
- Off** --- Use 8-bit color depth for HDMI outputs.

## 3D

Output in 3D form when playing 3D disc.

- On** --- Enable output in 3D form.
- Off** --- Disable output in 3D form.

## Audio Setup

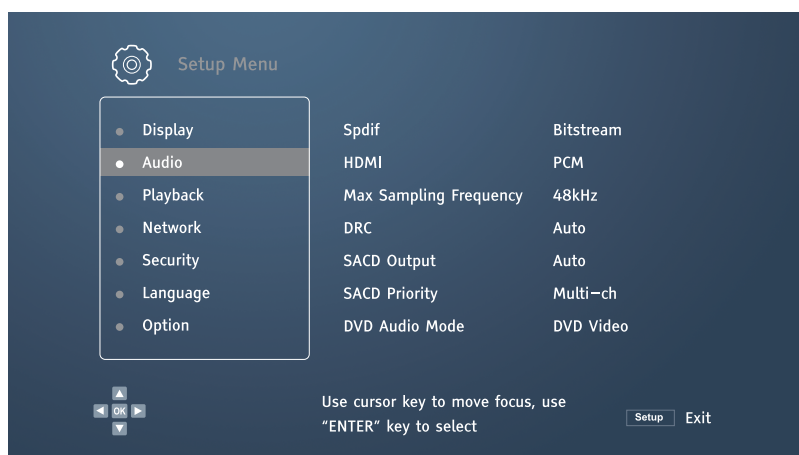

### Spdif

Set audio format output by SPDIF. Among the options, the upper limit upon sampling rate depends upon whether audio data is to be sampled at a lower frequency.

- Bitstream** --- Digital audios are output in formats of source codes.
- PCM** --- Digital audios are output in a multi-track linear PCM (LPCM) format.
- Off** --- Audio data is not output through spdif.

### HDMI

Set audio format of HDMI outputs.

- Bitstream** --- Digital audios are output in formats of source codes.
- PCM** --- Digital audios are output in a multi-track linear PCM (LPCM) format.
- Off** --- Audio data is not output through HDMI.

### Max Sampling Frequency

- 48kHz (default)** --- Compulsorily down mixed into 48K dual-track linear PCM (LPCM) digital audio format for outputting.
- 96kHz** --- Compulsorily down mixed into 96K dual-track linear PCM (LPCM) digital audio format for output.
- 192kHz** --- Compulsorily down mixed into 192K dual-track linear PCM (LPCM) digital audio format for output.

## DRC

- Off** --- When this setting is chosen, audio signals can be output without using the DRC function.
- On** --- Choose this setting and adjust the range between the noisiest and the gentlest sound (functional range), and play at the average volume. Please use this setting when it is hard to hear dialogues or when you watch a movie late at night.
- Auto (default)** --- Choose this option, to set for automatically opening/closing DRC based on input audio signals of discs.  
This will impact Dolby TrueHD signals only.

## SACD Output

- Auto (default)** --- Automatically choose the output format. If supported by the connected device, DSD will be output. Otherwise, PCM will be output.
- PCM** --- Convert SACD data into multi-track and high-resolution PCM data. The converted PCM data are output through HDMI, or output through the output analog audio port after processing by the internal DAC (digital analog converter).
- DSD** --- Direct stream digital (DSD) of SACD is not converted at all, but directly output through HDMI. For analog audio output, DSD data are directly converted into analog signals via internal DAC.

## Notes

- Owing to copyright and broadband limitations, optical/coaxial transmission of DSD audio data is impossible.

## SACD Priority

Choose to play an audio layer of the Super Audio CD (SACD).

- Multi-ch (default)** --- Play high-definition multi-track surround sound audio layer.
- 2-ch** --- Play high-definition dual-track stereo audio layer.
- CDDA** --- Play CD layer of SACDs.

## DVD Audio Mode

Choose the mode for playing DVD Audio.

- DVD Audio** --- Play high-definition audios of DVD Audio.
- DVD Video** --- Play videos of DVD Audio discs.

## Playback Setup

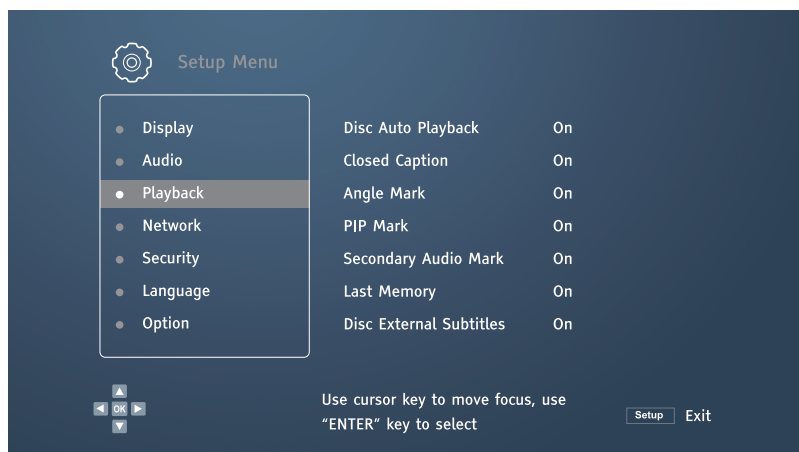

### Disc Auto Playback

- On (default)** --- The player will automatically start playing the disc right after a disc is inserted into it.
- Off** --- The compact disc will not be automatically played after it is inserted into the player. It will not start playing the disc until the user presses the **playing key**.

### Closed Caption

- On (default)** --- Turn on CC (Close Caption) display.
- Off** --- Turn off CC (Close Caption) display.

### Angle Mark

To play a multi-angle disc, you can enable or disable the multi-angle reminder function.

- On (default)** --- Enable the function for displaying multi-angle marks.
- Off** --- Disable the function for displaying multi-angle marks, to not affect normal viewing.

### PIP Mark

To play a disc with pictures-in-pictures, enable or disable to picture-in-picture reminder function.

- On (default)** --- Enable the picture-in-picture reminder function.
- Off** --- Disable the picture-in-picture reminder function, to not affect normal viewing.

### Secondary Audio Mark

To play a disc with the second audio, enable or disable the second audio reminder function.

- On (default)** --- Enable the second audio reminder function.
- Off** --- Disable the second audio reminder function, to not affect normal viewing.

### Last Memory

Select whether disc playback will start from the previously saved point or not. This setting applies to CDs, SACDs, DVDs and certain Blu-ray Discs.

**On (default)**      --- Playback automatically starts from the previously saved point.

**Off**                --- Playback starts from the beginning.

### Disc External Subtitles

Load external subtitles from the root directory of the USB storage device while playing the disc.

**On**                 --- Enable load external subtitles.

**Off**                --- Disable load external subtitles.



## Network Setup

For network setting on the setting menu, you can configure parameters for the player network, test connections and set access to BD-Live.

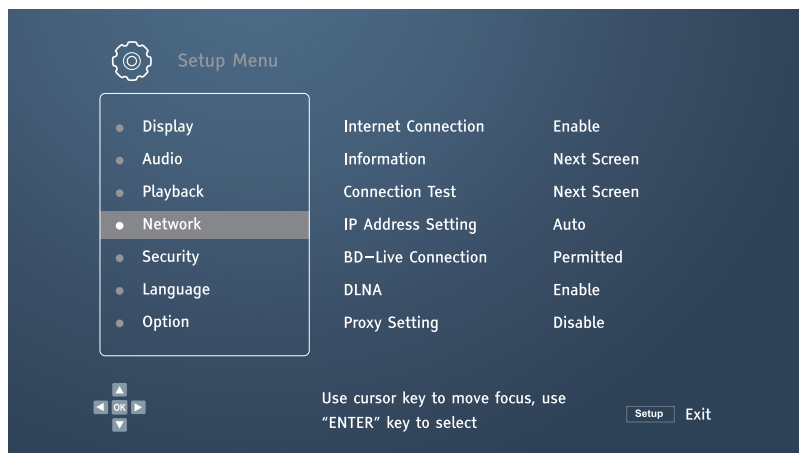

### Internet Connection

Choose whether to enable the Internet.

- Enable (default)**    ---    Enable the Internet.
- Disable**            ---    Disable the Internet.

### Information

Display information on current Internet connections, including connection type, IP address and Ethernet MAC address.

### Connection Test

Test if the player is connected to the Internet and display the test results.

### IP Address Setting

Choose the method for the player to acquire an IP address.

- Auto (default)**    ---    The player automatically acquires information on IP addresses through the dynamic host configuration protocol. This is a default setting. In most cases, automatic IP configuration has to be used.
- Manual**            ---    Manually enter the IP address, subnet mask, gateway and DNS. When a router cannot function as a DHCP server or the DHCP server is disabled, choose this mode. Press **CLEAR** on the keyboard to clear the edited content.

## BD-Live Connection

Choose the BD-Live content to be accessed.

- Permitted (default)** --- Grant access to all BD-Live content.
- Partially Permitted** --- Only grant access to content with effective ownership certificate. Access to the BD-Live content without certificate will be banned. This option ensures you that you will only access reliable information and hinder you from accessing some small-scale independent content providers as far as possible.
- Prohibited** --- Ban access to BD-Live.

## DLNA

- Enable (default)** --- Enable DLNA.
- Disable** --- Disable DLNA.

## Security Setup

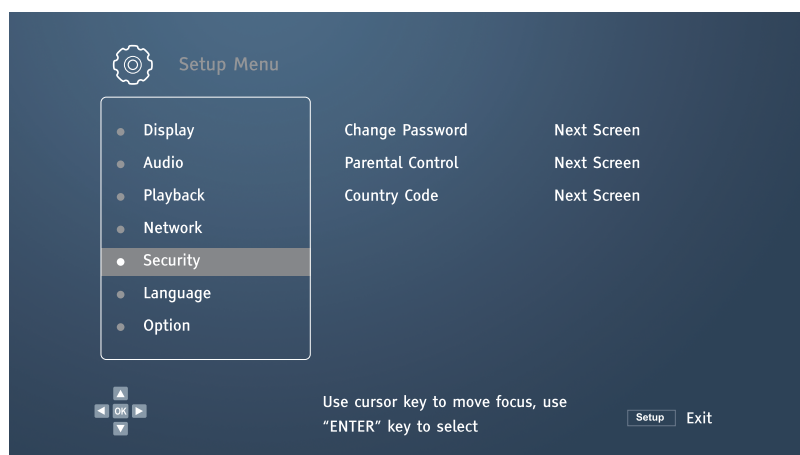

To prevent minors from viewing unhealthy content, you can set child lock control level. This function only works for correctly graded and numbered discs.

The default password is "0000".

### Change Password

Change the grading control password. The current password can be replaced by a new one after it is entered.

### Parental Control

Choose DVD class by the up/down key. The effective classes include OFF, Kid, G, PG, PG-13, PGR, R, NC-17 and Adult. The discs with lower classes than the chosen one can be viewed, while those with the chosen class or higher will be banned from viewing. All discs can be played if this function is disabled.

### Country Code

Classes of some Blu-ray discs might vary in different countries. At present, the player only supports hierarchical control placed in the United States.

## Language Setup

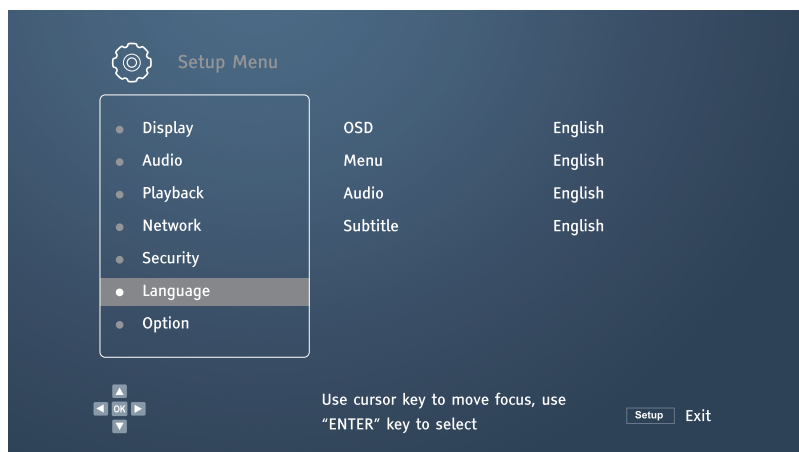

**Language:** Configures language preferences. This menu contains the following sub-items:

### OSD

Allows you to choose the language for the player's Setup Menu and the on-screen display. Currently the player supports 13 languages.

### Menu

Allows you to choose the preferred language for displaying DVD and Blu-ray Disc menus. If a disc menu of the selected language is available, that menu will be shown instead of the default disc menu.

### Audio

Allows you to choose the preferred audio language for DVD and Blu-ray Discs. If an audio track of the selected language is available on the disc, the audio track will be played back.

### Subtitle

Allows you to choose the preferred subtitle language for DVDs and Blu-ray Discs. If a subtitle of the selected language is available, it will be displayed. When Auto is selected, the subtitle display is determined by the disc.

## Other Setup

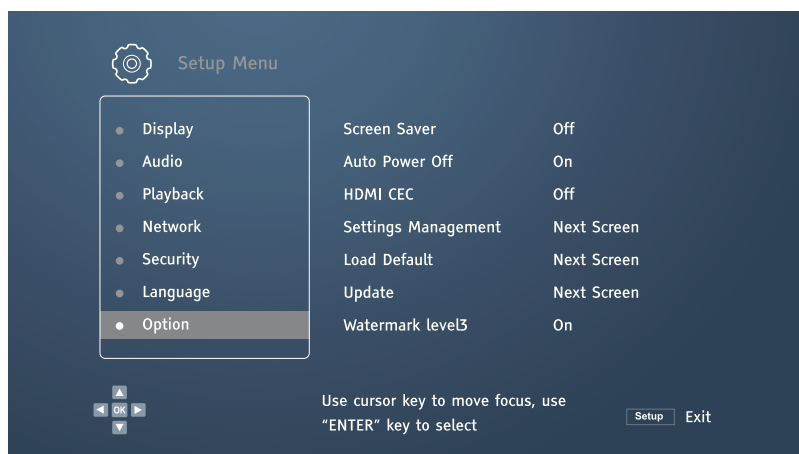

### Screen Saver

Enable/Disable screen saver. The screen saver is designed to minimize burn-in concerns for plasma and CRT display devices.

- 1 min** --- If no operation is performed over one minute, the screen protection program will be enabled.
- 3 min** --- If no operation is performed over three minutes, the screen protection program will be enabled.
- 10 min** --- If no operation is performed over one ten minutes, the screen protection program will be enabled.
- Off** --- The screen protection is not activated. You can choose this option if your TV set has no aging problem.

### Auto Power Off

To allow the player to auto-shutdown after 30 minutes of inactivity. This can help reduce power consumption and prolong the service life of you player.

- On** --- Enable the Auto Power Off.
- Off** --- Disable the Auto Power Off.

### HDMI CEC

Set HDMI CEC mode. CEC is an optional HDMI function. It is convenient for placing remote control and automatically setting by connecting to the CEC of the player. The remote control function makes it possible for you to control multiple connected devices by HDMI using a single remote control. For instance, control a Blu-ray player with a TV remote control. With the remote control function, the player will be automatically powered off when you turn off the TV set. Realization and compatibility of HDMI CEC vary among equipment manufacturers. HDMI CEC might only have some or special functions.

- HDMI1 ON** --- Enable CEC via HDMI1.
- HDMI2 ON** --- Enable CEC via HDMI2.
- Off (default)** --- Disable CEC.

## Settings Management

Allows you to backup or restore the player settings. This option affects the settings in Setup Menu. It does not export/import private information.

- Export** --- Export the player settings to the first detected USB storage device. The player will create a new configuration file named "config\_file.txt", and the settings will be stored in binary format which can only be accessed by MAGNETAR technical support.
- Import** --- Restore the player's settings from external USB storage. The player will access the first detected USB storage device for the configuration file. To avoid any confusion, we recommend only connect one USB storage device to the player at this time.

## Load Default

Restore all factory settings, including passwords of all accounts.

## Update

Upgrade player firmware. This option will be only available when the player contains no disc or completely stops. Firmware is system software with functions for controlling the player. Since specifications for Blu-ray discs are new and being constantly improved, the Blu-ray discs issued after production of these players would adopt new specifications and have new functions. Therefore, to ensure optimal viewing experiences, the player firmware has to be updated from time to time.

Please browse magnetar's website ([www.magnetar-audio.com](http://www.magnetar-audio.com)) to check new firmware and upgrading instructions.

- USB Storage** --- You can download the latest firmware from the official website of magnetar to a USB flash disk. Then, use this disk for upgrading the player firmware.
- Network** --- If the network to which your player is connected is normal, you can upgrade your player firmware through the network.

## BUDA

Manage BD-Video data memory. BD-Video data memory is used for storing additional content of BonusView and BD-Live. Once the player is powered off, the data will be further saved.

- BUDA Information** --- Display used space of the current storage device. If the space available is small, some Blu-ray discs wouldn't be normally planed.
- BUDA Setup** --- Choose where to save the BD-Video data.

## About Player

Display firmware version number and some other information of the player.

## Other Data

### Reminders

- To prolong service life of the player, you'd better not power the player on again until at least 30 seconds after the player is powered off.
- After use, please take the compact disc out and power the player off.
- In playing some compact discs, certain functions of the player would be unavailable.
- The player would not fully support tidbits of certain compact discs, but this is not a fault of the player.
- If the player malfunctions, please power the player off, and don't power it on again until 30 seconds later.

## Troubleshooting

You can choose general operation problems as shown in the table here below.

Faults	Potential Causes	Solutions	Remarks
No sound	The audio cable is incorrectly connected	Inspect the audio cable and please reconnect the cable when necessary	
	Mute mode is turned on	Press MUTE to cancel the mute mode	
	Volume is too low	Press Volume + to raise volume to 100	
	When SACD is played, the audios connected are coaxial or optical and digital	This connection mode is not supported for the time being due to copyright limits of SACD. Please choose analog or HDMI audio output. Or you can set SACD priority as CD mode so that the player will play the CD layer.	
	In playing DVD-Audio, the audios connected are coaxial or optical and digital	This connection mode is not supported for the time being due to copyright limits of DVD-Audio. Please choose analog or HDMI audio output. Or you can switch to the DVD-Video playing mode.	
No image	The video cable is incorrectly connected	Inspect the video cable and reconnect it when necessary	
	TV input source is incorrectly chosen	Choose player input	
	Under the "pure tone" mode	Press PURE TONE to cancel this mode	
	TV sets don't support this video output format	Choose output resolution suitable for your TV set	
No color	Saturation setting is too low	Check saturation settings of your TV set and player	
Color is wrong	Color space is incorrectly set	To output videos through HDMI, please check color space settings of your TV set and player	
"No compact disc" or "unknown disc" error	The player contains no compact disc or the compact disc is incompatible	Take the compact disc out for inspection	
	The recording side of the disc is	Take the disc out and clear the dirt/stain or fingerprint off the disc.	

Other data

Faults	Potential Causes	Solutions	Remarks
	dirty		
	The disc is put upside down	Take the disc out to make sure that the printing side will be upward, while the recording side will be downward.	
	The laser head condensates	Open the player and take the disc out. Keep the player open for one hour.	
Remote control malfunctions	Remote control is too far away	Use remote control within effective distance	
	Battery is low	Replace batteries	
Temporary malfunctions	The disc is scratched on the surface or damaged	Replace the disc	
	Some functions don't work during playing	Try again after the player fully stops playing	
	Interference of other devices	Power off other devices to inspect their interference. Then, replace the devices which interfere with the player or put them in other places.	
Some set menu options become gray	While a disc is being played, some set options cannot be altered. Certain set options and others would be mutually exclusive	Try setting the menu again after the player fully stops playing and the disc pops out.	
"Connection test" fails	The player cannot be connected to the Internet.	Check if the router is connected to the Internet. Try restarting the modem and the router. If possible, please try directly connecting your player to Ethernet.	
"The network" displays that no server is available.	No Internet connection.	Check if other network functions of the player are normal. If it is certain that there are problems with "network" functions, please refer to instructions on media server, to ensure that configurations are correct.	



## Product Specifications and Parameters

The Company reserves the right to alter product designs and specifications without further notice.

Disc type *	UHD Blu-ray, Blu-ray, Blu-ray 3D, DVD-Video, DVD-Audio, AVCHD, SACD, CD, Kodak Picture CD, CD-R/RW, DVD±R/RW, DVD±R DL, BD-R/RE
Output	Analog audio: Stereo Independent stereo analog audio: XLR balanced output, RCA output. Optical/coaxial audios: 2-track at maximum/192kHz PCM, Dolby Digital, DTS. HDMI audios: 7.1-track at maximum/192kHz PCM, 5.1-track (maximum) DSD, Bitstream. HDMI videos: UHD/1080p24/1080p/1080i/720p/576p/576i/480p/480i.
Characteristics of analog audios ** (Stereo audio output)	Frequency range: 20 Hz - 20 kHz (-3dB ~ +0.05dB) Signal-to-noise ratio > 120dB Total harmonic distortion + noise < 0.00018% Output level: (RCA) 2.1±0.2Vrms. (XLR) 4.2±0.4Vrms Dynamic range > 120dB Channel separation > 120dB
General specifications	Power supply: AC 100-240V ~, 50/60Hz Power: 30 W (standby: 0.5 W under the energy-saving mode) Dimension: 430 mm x 300 mm x 86 mm Weight: about 8 kg
Working temperature	41°F – 95°F 5°C – 35°C
Working humidity	15% – 75% No condensation

\* Due to diversity of used multimedia, software and technologies, compatibility of user codes or users' own discs cannot be guaranteed.

\*\* Nominal specifications

# RS-232 Control Protocol

UDP800 has a RS-232 interface with wired remote control. The interface pins are described as follows:

Pins	2	3	5
Signals	Transmit data (TXD)	Receive data (RXD)	Ground (GND)

This pin configuration allows connection of a personal computer to the player by a straight-through 9-pin RS-232 serial cable, and a serial terminal (e.g. Hyper Terminal) is operated for communication. Please don't connect the player to your personal computer through any "Null-Modem" cable.

To understand how to create connections, please refer to the document on remote control system.

## Communication Configuration

Baud Rate	115200
Stop Bit	1
Data Bit	8
Parity Bit	N/A
Flow Control	N/A

## Command Structure

Each command starts with "#" (ASCII code is 0x23), followed by one 3-character command code. It ends with a line feed upon carriage return (ASCII code is 0x0d 0x0a).

The command structure is exemplified as follows:

<Command> = <start symbol><command code><end symbol>

<Start symbol of command> = # (ASCII 0x23)

<Command code> = <byte><byte><byte>

<Parameters>=specific commands

<End symbol of command> = carriage return (ASCII 0x0d) [line feed (ASCII 0x0a)]

## Response Structure

The player will execute the command and send a response back after receiving it. Character string of the response is "ack".

## Commands

Command Codes	Remote Control Keys	Functions	Response Instances
POW	Power	Put the player under the “standby” state	ack
EJT	Ejector Opening/Closing	Open/close the ejector	ack
PON	Power On	Power the player “on”	ack
POF	Power Off	Power the player “off”	ack
DIM	Dimming	Adjust display luminance of front panel	ack
PUR	Pure Tone	Pure tone mode (switch off video output)	ack
VUP	Volume +	Raise volume	ack
VDN	Volume -	Lower volume	ack
MUT	Mute	Turn off audios	ack
NU1	1	Number Key 1	ack
NU2	2	Number Key 2	ack
NU3	3	Number Key 3	ack
NU4	4	Number Key 4	ack
NU5	5	Number Key 5	ack
NU6	6	Number Key 6	ack
NU7	7	Number Key 7	ack
NU8	8	Number Key 8	ack
NU9	9	Number Key 9	ack
NU0	0	Number Key 0	ack
CLR	Clear	Clear digital input	ack
GOT	Jump	Jump to the designated point to start playing	ack
HOM	Main Menu	Open the main menu to choose media sources	ack
OSD	Information	Display/hide displayed information	ack
TTL	Disc Menu	Display title menu of a Blu-ray disc or DVD	ack
MNU	Popup Menu	Display popup menu of a Blu-ray disc or DVD	ack
NUP	Up	Navigation	ack
NLT	Lef	Navigation	ack
NRT	Right	Navigation	ack
NDN	Down	Navigation	ack
SEL	Confirm	Navigation	ack
SET	Set	Open setting menu of the player	ack
RET	Return	Return to the previous menu or mode	ack
RED	Red	Functions vary with content	ack
GRN	Green	Functions vary with content	ack

## RS-232 Control Protocol

BLU	Blue	Functions vary with content	ack
YLW	Yellow	Functions vary with content	ack
STP	Stop	Stop playing	ack
PLA	Play	Start playing	ack
PAU	Pause	Pause playing	ack
PRE	Rebounce	Jump to the previous song	ack
REV	Fast Backward	Play fast backward	ack
FWD	Fast Forward	Play fast forward	ack
NXT	Next	Jump to the next song	ack
AUD	Audio Track	Choose track or dubbing language	ack
SUB	Caption	Choose caption language	ack
ANG	Angle	Choose angle of view	ack
ZOM	Zoom	Zoom up/down and adjust image ratio	ack
SAP	Second Audio	Enable/disable the second audio and menu. Down mix sound effects into main audios.	ack
ATB	AB Repeat	Repeat playing the chosen segment	ack
RPT	Repeat	Repeat playing	ack
PIP	Picture-in-picture	Display/hide picture-in-picture	ack
HDM	Resolution	Switch output resolution	ack
SUH	Caption (hold)	Keep pressing the caption key to enable the function for setting caption positions	ack
OPT	Option	Display/hide option menu	ack
SEH	Image Adjustment	Adjust image brightness, contrast and saturation, etc.	ack
HDR	HDR	Display HDR selection menu	ack

---

## Names and Contents of Toxic and Hazardous Substances or Elements

Material Types	Lead	Mercury	Cadmium	(Cr6+)	(PBB)	(PBDE)
	(Pb)	(Hg)	(Cd)			
Baseplate for Assembly	X	○	○	○	○	○
Casing	X	○	○	○	○	○
Optical Module	X	○	X	○	○	○
Drive Unit	X	○	○	○	○	○
Accessories (Cables and Remote Control, etc.)	X	○	○	○	○	○

○ indicates that content of a toxic and hazardous substance in all homogeneous materials of a component is below the limit specified by SJ/T11363-2006.

x means that content of a toxic and hazardous substance in at least one homogeneous material of a component exceeds the limit specified by SJ/T11363-2006.

### Notes

Upon test, this machine is found to conform to the rules of EMC Directive on use of cables connected within 3m.

---

## Instructions on Warranty Card for Magnetar Products

### I. According to related national laws and regulations, three warranties will be granted

Users of Magnetar products will receive complete services on three warranties according to the Rules on Responsibilities for Repair, Replacement and Return of Household Auditory Products promulgated by related national authorities on July 23, 2002.

### II. Warranty Principle

1. Any products which malfunction in normal use and have not been disassembled for repair may be freely returned within seven days after purchase, and replaced within 15 days after purchase, subject to one-year warranty.
2. In the following cases, free replacement and repair will not be performed, but paid maintenance services will be available:
  - a. Damages caused by human factors, including operations under abnormal working environment (humid and dusty) and failure to use in compliance with the manual;
  - b. Users disassemble, repair or alter the products without authorization, or use firmware of other companies other than MAGNETAR's or have the products repaired by organizations other than our joint warranty service providers;
  - c. Damages caused by force majeure or natural disasters (e.g. flood, fire, earthquake and lightning strike);
  - d. No effective purchase voucher is provided;
  - e. The purchase voucher is not in line with product model or altered. The product type and code are torn away;
  - f. The products are not for normal household use, but utilized as engineering, test or commercial samples.

### III. Warranty Method

1. For warranty services, an effective purchase voucher must be presented.
2. You can have the product which satisfies the requirements for free replacement replaced with the sales outlet from which you've purchased the product. For replacement of any product with host fault, in principle, we will only provide the same type of host for free replacement.
3. You can have the products to be repaired (if necessary) repaired at any joint warranty service provider within our national joint warranty network (excluding Hong Kong, Macao and Taiwan), or send the products back to our Aftersales Service Department for repair.

#### Notes:

1. Before product use and in case of faults, please carefully read this manual.
2. Please carefully read the "notes" of this manual.

Manufacture: Magnetar Technology Shenzhen Co., Ltd.

Address: Room 211, 1<sup>st</sup> Building, 26 Puzhai Road, Pingdi Street Center, Longgang District, Shenzhen

Website: [www.magnetar-audio.com](http://www.magnetar-audio.com)

