

marantz®

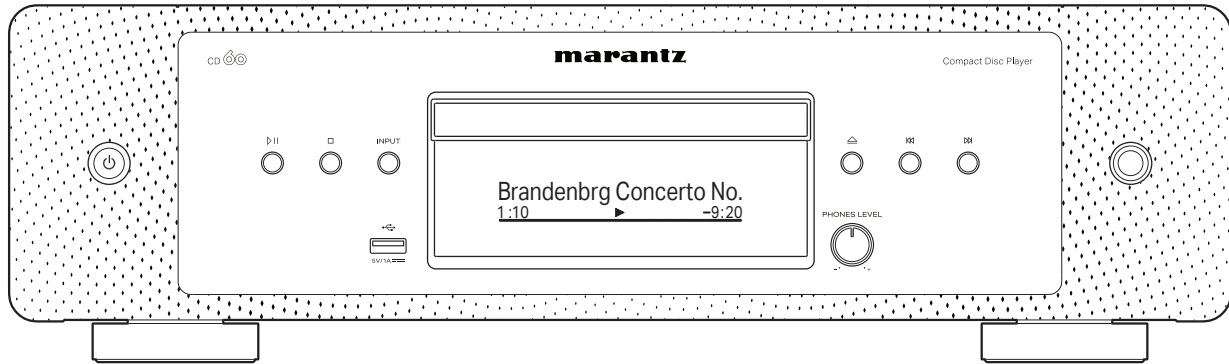

CD  | CD Player

QUICK START GUIDE

Before you begin

What's in the box

Quick start guide

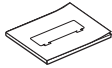

Safety Instructions



Warranty
(for USA/for CANADA)

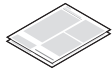

CD Player

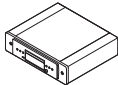

Power cord



Remote control
(RC005PMCD)



2× R03/AAA batteries



Audio cable



Remote connector
cable



Required for setup

Amplifier

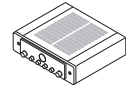

Speakers



Speaker cables



Setup

1 Connect the amplifier

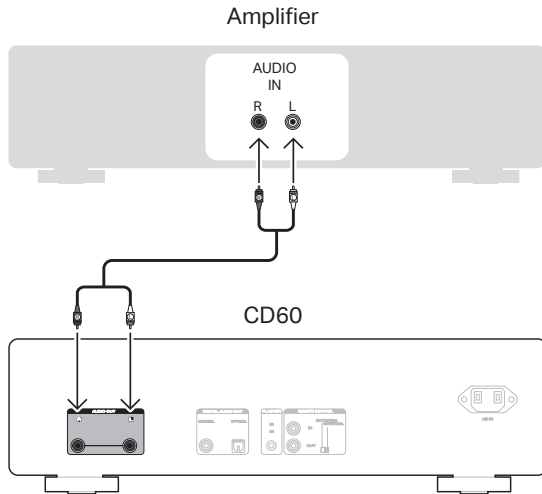

2 Connect to power

Connect the power cord between the CD60 and a wall outlet.

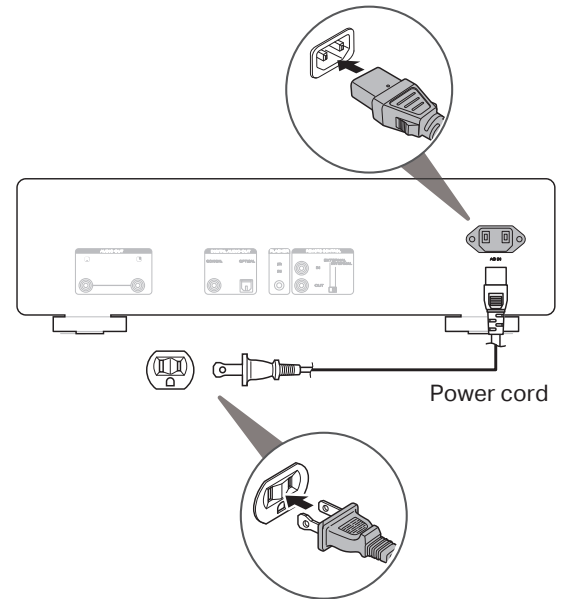

3 Install batteries in the remote control

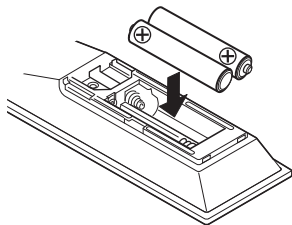
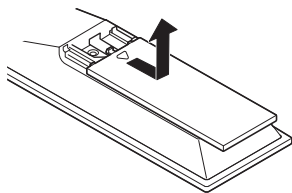

- Batteries can be taken out in reversed order.

4 Begin CD playback

1 Press CD .

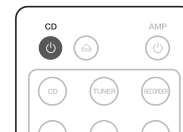

2 Press  to open the disc tray.

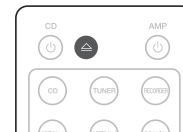

3 Place CD in the disc tray.

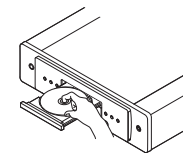

4 Press  to start playback.



Contact Marantz

 **1-800-654-6633**

We hope you will enjoy your Marantz product for years to come. If you ever have any question or need any support, just get in touch via the free helpline. We are happy if you are happy.

In case you can't reach the helpline please check the support section on **www.marantz.com** for more information.

Owner's manual

Refer to the online manual for other functions information and operation procedure details.

manuals.marantz.com/CD60/NA/EN/



Online manual

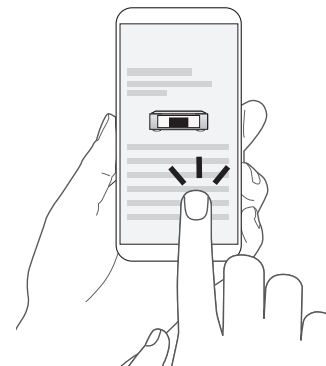

www.marantz.com

You can find your nearest authorized distributor or dealer on our website.

marantz[®] is a registered trademark.

Printed in Vietnam 5411 11986 00AM
© 2022 Sound United. All Rights Reserved.