

SONY

VPL-VW790ES

Home Cinema entertainment
at its very finest



SXR D

X1
for projector

Z-Phosphor
LASER LIGHT SOURCE

At a glance

- Native 4K resolution: 4096x2160
- 2,000 ANSI lumens
- Laser light source, 20,000hours virtually maintenance free
- 'X1 for Projector' picture processing
- Dynamic HDR Enhancer for spectacular HDR images
- Infinite dynamic contrast with dual contrast engine
- Digital Focus Optimizer (DFO) for enhanced corner to corner clarity

An ideal choice to fit in your theater room. The VPL-VW790ES, with Dynamic HDR Enhancer and Digital Focus Optimizer functions, brings movies to life with extraordinary cinematic detail, color, and contrast that you'd expect from a much bigger, more costly projector. Savor the action with 2,000 lumens of brightness, delivered by the long-lasting laser light source, and see vibrant images in dark or well-lit rooms.

Dynamic HDR Enhancer

Deliver the optimal projected HDR experience through Sony's advanced scene by scene HDR processing. Achieve striking highlights whilst maintaining deep black levels.

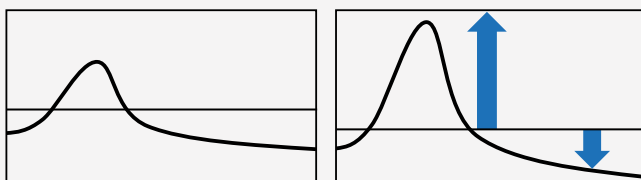
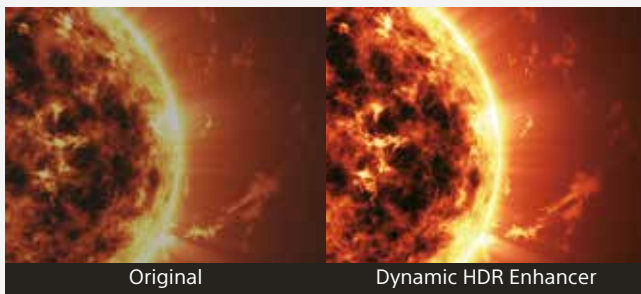

Digital Focus Optimizer

Optimum focus is achieved not only optically, but also digitally. By analyzing every pixel of the images with our own algorithm and detecting possible degradation in advance, the Digital Focus Optimizer performs optimum image quality correction so that the focus is better than ever, even in the corners.

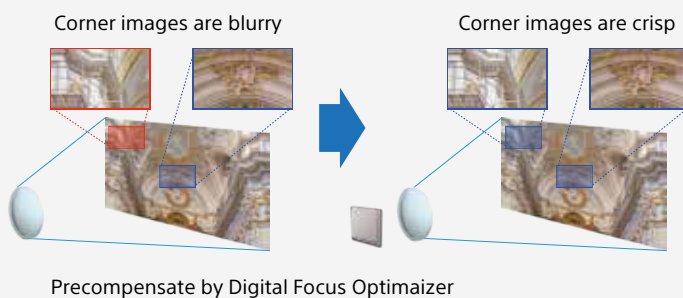

Native 4K SXRDTM panel

Sony's advanced SXRDTM (Silicon X-tal Reflective Display) panel technology featured in Sony's digital cinema projectors delivers native 4K (4096 x 2160) resolution images, with more than four times the detail of Full HD. Fine details are wonderfully clear and natural, without jagged edges or visible pixels.



Laser Light Engine

Sony's Z-Phosphor laser light engine offers enhanced picture quality with consistent brightness and colours for the long term. Also there are operational benefits with virtually zero maintenance for 20,000 hours, with no lamp or filter changes, and fast on/off so you can enjoy your content quicker than ever before.



Dual Contrast Control

Both the iris control and laser can be adjusted independently and dynamically, to optimize light output for both dark scenes, and those with high contrast. The result is deeper blacks than ever, as infinite dynamic contrast makes every scene spring to life with detail and realism.



Specifications

		VPL-VW790ES
Display system		4K SXRD panel, projection system
Display device	Size of effective display area	0.74" x 3
	Number of pixels	26,542,080 (4096 x 2160 x 3) pixels
Projection lens	Focus	Powered
	Zoom	Powered (Approx. x 2.06)
	Lens shift	Powered, Vertical: +85 % -80 %, Horizontal: +/-31 %
		-
	Throw ratio*1	1.38 : 1 to 2.83 : 1
Light source		Laser diode
Recommended lamp replacement time*2		-
Light output		2,000 lm
Dynamic contrast		∞ : 1
Accepted digital signals		720 x 576/50p, 720 x 480/60p, 1280 x 720/50p, 1280 x 720/60p, 1920 x 1080/50i, 1920 x 1080/60i, 1920 x 1080/24p, 1920 x 1080/50p, 1920 x 1080/60p, 3840 x 2160/24p, 3840 x 2160/30p, 3840 x 2160/50p, 3840 x 2160/60p, 4096 x 2160/24p, 4096 x 2160/25p, 4096 x 2160/30p, 4096 x 2160/50p, 4096 x 2160/60p
Input Output (Computer / Video / Control)	HDMI	x 2 (HDCP2.2)
	Display Port	-
	Trigger	x 2 (Mini jack, DC 12 V, Max. 100 mA)
	RS-232C	x 1 (D-sub 9-pin (male))
	LAN	x 1 (RJ-45, 10BASE-T/100BASE-TX)
	IR IN / OUT	IN: x 1 (Mini jack)
	3D SYNC OUT	-
	USB	x 1 (Type A, DC 5 V, Max. 500 mA)
Picture processor		X 1 for projector
Object-based HDR remaster		-
Dynamic HDR Enhancer		Yes
Object-based Super Resolution		-
Super Resolution		Yes
Dual database processing		-
Digital Contrast Optimizer		-
Digital Focus Optimizer		Yes
Dynamic contrast control		Dual contrast control (Laser and Iris)
Motionflow		Yes
HDR Format		HDR10/HLG
3D		Yes
Picture position memory		5
Input lag reduction		Yes (4K/2K)
Acoustic noise*3		24 dB
Power requirements		AC 100-240 V, 50/60 Hz
	Power consumption	430 W
Standby		0.4 W (when "Remote Start" is set to "Off")
	Networked Standby	1.0 W (LAN) (when "Remote Start" is set to "On")
Dimensions (Without Protrusions)		W 560 x H 223 x D 496 mm (W 22 1/16" x H 8 25/32" x D 19 17/32 in)
Mass		Approx. 20 kg / 44 lb
Supplied accessories		RM-PJ24 Remote Commander (1), Size AA (R6) Manganese Batteries (2), AC Power Cord (1), Lens Cap (1), Operating Instructions (CD-ROM) (1), Quick Reference Manual (1), Safety Regulations (1)
Optional accessories		-

Dimensions

CONNECTOR PANELS



Front

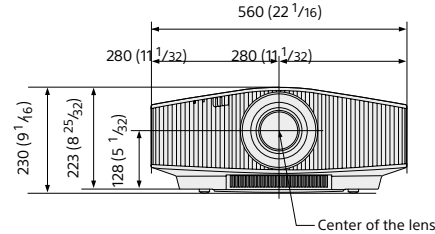

Bottom

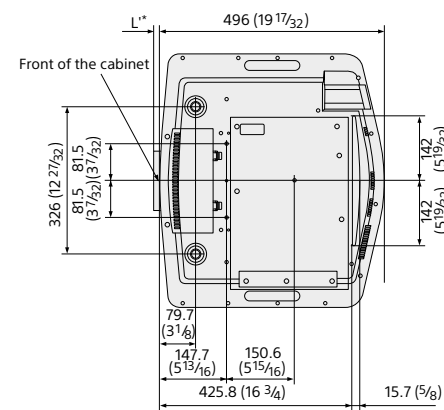

Optional Accessories



X105-RF-X1
XpanD 3D Glasses

Projection distance

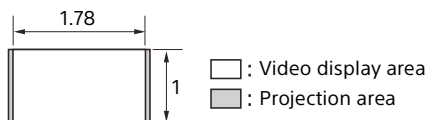

1.78:1 (16:9)		
Projection image size		Projection distance L
Diagonal	Width x Height	
80" (2.03 m)	1.77 x 1.00 (70 x 39)	2.44 - 5.01 (96 - 197)
100" (2.54 m)	2.21 x 1.25 (87 x 49)	3.05 - 6.28 (121 - 247)
120" (3.05 m)	2.66 x 1.49 (105 x 59)	3.67 - 7.55 (145 - 297)
150" (3.81 m)	3.32 x 1.87 (131 x 74)	4.60 - 9.44 (181 - 371)
200" (5.08 m)	4.43 x 2.49 (174 x 98)	6.15 - 12.61 (242 - 496)

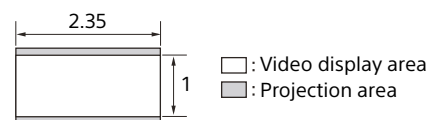

2.35:1		
Projection image size		Projection distance L
Diagonal	Width x Height	
80" (2.03 m)	1.87 x 0.80 (74 x 31)	2.41 - 4.96 (95 - 195)
100" (2.54 m)	2.34 x 0.99 (92 x 39)	3.02 - 6.22 (119 - 244)
120" (3.05 m)	2.80 x 1.19 (110 x 47)	3.64 - 7.47 (143 - 294)
150" (3.81 m)	3.51 x 1.49 (138 x 59)	4.55 - 9.35 (180 - 368)
200" (5.08 m)	4.67 x 1.99 (184 x 78)	6.08 - 12.48 (240 - 491)

© 2020 Sony Corporation.

All rights reserved. Reproduction in whole or in part without permission is prohibited. Features and specifications are subject to change without notice. All non-metric weights and measurements are approximate. 'Sony' is a registered trademark of Sony Corporation. All other trademarks are the property of their respective owners. Errors and omissions excepted.

www.pro.sony  @SonyDisplays

Follow us on  **LinkedIn**.

SONY

Distributed by

